

Panasonic

Telephone Answering System
with Facsimile

Model No. **KX-F780**

OPERATING INSTRUCTIONS



Please read these Operating Instructions before using the unit and save for future reference.

**FOR OPERATION ASSISTANCE,
CALL 1-800-HELP-FAX (1-800-435-7329)**

- This product is designed for use in the United States of America, and may not operate in other countries. (See page 76 for more details.)
- Este producto ha sido diseñado para su uso en los Estados Unidos de América, y puede no funcionar correctamente en otros países. (Consulte la página 76 para tener más detalles.)

Contents

Installation and Connection	p. 6
Initial Preparation	p. 11
Basic Operations	p. 17
Advanced Operations	p. 32
Troubleshooting and Routine Care	p. 65
General Information	p. 72

Thank you for purchasing the Panasonic Telephone Answering System with Facsimile.

Things you should keep records of

Attach your sales receipt here

For your future reference

Date of purchase _____ Serial No. _____
(found on the bottom of the unit)

Dealer's name and address _____

Dealer's telephone number _____

Caution:

The Telephone Protection Act of 1991 requires the following information to be clearly stated either at the top or bottom margin of the first message page when transmitting messages via telephone facsimile;

- Date and time of transmission,
- Identification of the business, entity or person(s) sending the facsimile, and
- Telephone number of the business, entity or person(s).

To program this information into your facsimile machine, complete all the instructions on pages 11 through 13.

Copyright:

This manual is copyrighted by Kyushu Matsushita Electric Co., Ltd. (KME) and its licensee. Under the copyright laws, this manual may not be reproduced in any form, in whole or part, without the prior written consent of KME and its licensee.

© Kyushu Matsushita Electric Co., Ltd. 1996

Included accessories (To order, call toll free 1-800-332-5368.)

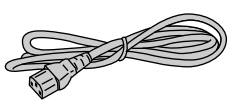
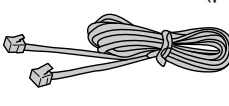
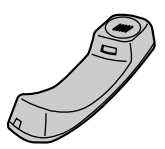
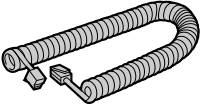
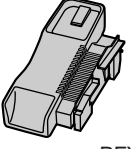
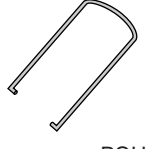
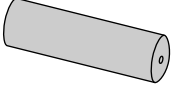
<p>Power cord 1 pc. (p. 10)</p>  <p>PQJA200Z</p>	<p>Telephone line cord 1 pc. (p. 10)</p>  <p>PQJA59V</p>	<p>Handset 1 pc. (p. 8)</p>  <p>PFJXE0108Z</p>	<p>Handset cord 1 pc. (p. 8)</p>  <p>PQJA212N</p>
<p>Handset cradle 1 pc. (p. 8)</p>  <p>PFYAF780M</p>	<p>Paper stacker 1 pc. (p. 9)</p>  <p>PQUS10136Z</p>	<p>Recording paper 1 pc. (p. 9)</p>  <p>—See page 75 for replacement of the recording paper.</p>	

- If any items are missing, check with place of purchase.
- The part numbers listed above are subject to change without notice.
- Save the original carton and packaging.

Important safety instructions

When using this product, basic safety precautions should always be followed to reduce the risk of fire, electric shock, and injury to persons, including the following:

1. Read and understand all instructions.
2. Follow all warnings and instructions marked on this product.
3. Unplug this product from wall outlets before cleaning. Do not use liquid or aerosol cleaners. Use a damp cloth for cleaning.
4. Do not use this product near water, for example, near a bath tub, wash bowl, kitchen sink, or laundry tub, in a wet basement, or near a swimming pool.
5. Do not place this product on an unstable cart, stand or table. The product may fall, causing serious damage to the product or personal injury.
6. Slots and openings in the cabinet and the back or bottom are provided for ventilation, to protect it from overheating. These openings must not be blocked or covered. The openings should never be blocked by placing the product on the bed, sofa rug, or other similar surface. This product should never be placed near or over a radiator or heat register. This product should not be placed in a built-in installation unless proper ventilation is provided.
7. This product should be operated only from the type of power source indicated on the marking label. If you are not sure of the type of power supplied to your home, consult your dealer or local power company.
8. This product is equipped with a three wire grounding type plug, a plug having a third (grounding) pin. This plug will only fit into a grounding type power outlet. This is a safety feature. If you are unable to insert the plug into the outlet, contact your electrician to replace your obsolete outlet. Do not defeat the safety purpose of the grounding type plug.
9. Do not allow anything to rest on the power cord. Do not locate this product where the cord could be damaged by people walking on it.
10. Do not overload wall outlets and extension cords as this can result in the risk of fire or electric shock.
11. Never push objects of any kind into this product through cabinet slots as they may touch dangerous voltage points or short out parts that could result in a risk of fire or electric shock. Never spill liquid of any kind on the product.
12. To reduce the risk of electric shock, do not disassemble this product, but take it to an authorized servicer when some service or repair work is required. Opening or removing covers may expose you to dangerous voltages or other risks. Incorrect reassembly can cause electric shock when the appliance is subsequently used.
13. Unplug this product from the wall outlet and refer servicing to an authorized servicer under the following conditions:
 - A. When the power supply cord or plug is damaged or frayed.
 - B. If liquid has been spilled into the product.
 - C. If the product has been exposed to rain or water.
 - D. If the product does not work normally by following the operating instructions. Adjust only those controls, that are covered by the operating instructions because improper adjustment of other controls may result in damage and will often require extensive work by an authorized technician to restore the product to normal operation.
 - E. If the product has been dropped or the cabinet has been damaged.
 - F. If the product exhibits a distinct change in performance.
14. Avoid using a telephone (other than a cordless type) during an electrical storm. There may be a remote risk of electric shock from lightning.
15. Do not use the telephone to report a gas leak in the vicinity of the leak.

SAVE THESE INSTRUCTIONS

INSTALLATION:

1. Never install telephone wiring during a lightning storm.
2. Never install telephone jacks in wet locations unless the jack is specifically designed for wet locations.
3. Never touch uninsulated telephone wires or terminals unless the telephone line has been disconnected at the network interface.
4. Use caution when installing or modifying telephone lines.

WARNING:

To prevent the risk of fire or electrical shock, do not expose this product to rain or any type of moisture.

OTHER INFORMATION

- Keep the unit away from electrical noise-generating devices, such as fluorescent lamps and motors.
- The unit should be kept free from dust, moisture, high temperature, and vibration.
- The unit should not be exposed to direct sunlight.
- Do not place heavy objects on top of this unit.
- Do not damage the power cord.
- Do not touch the plug with wet hands.
- Do not use benzine, thinner, or any abrasive powder, to clean the cabinet. Wipe it with a soft cloth.

Table of Contents

Installation and Connection

Location of controls	6
Installing your unit	8
Connections	10

Initial Preparation

Setting the date, time, logo and facsimile telephone number	11
Selecting the receive mode	14
Adjusting volumes	16

Basic Operations

Making voice calls	17
Answering voice calls	17
Transmitting documents	18
Receiving documents	21
Making a copy	28
Operating the answering device	29

Advanced Operations

Automatic dialing

Storing phone numbers for automatic dialing	32
Making voice calls using automatic dialing	33
Transmitting documents using automatic dialing	33
Electronic telephone directory	34

Telephone

Voice contact (talking to the caller during or after fax reception or transmission) ..	35
TONE, FLASH and REDIAL/PAUSE buttons	36

Facsimile

Polling (retrieving fax documents)	37
Delayed transmission (sending a fax at a later time)	38
Sending documents overseas	39
Remote fax receiving (using an extension to receive a fax message)	40
Junk mail prohibitor (preventing the reception of unwanted fax documents)	41
Receiving with distinctive ring service	42
Signaling your pager that you have received a fax document	43

Answering system

Voice mailbox (how callers can leave you private messages) 44
 Transferring incoming calls 47
 Operating the answering device from a remote phone 49
 Recording your own greeting messages 54

Special settings

Changing the caller's recording time 56
 Setting the message alert 56
 Setting the recording time alert 57
 Changing the recording time for the ANS/FAX greeting message 57
 Changing the logo print position 58
 Changing the display contrast 58
 Setting the friendly reception 59
 Setting the fax voice guidance 59
 Setting the handset switch 60
 Resetting the advanced features 60

Others

Summary of user programmable features 61
 Printing reports and lists 62

Troubleshooting and Routine Care

Error messages on the display 65
 Before requesting help 66
 Clearing a recording paper jam 68
 Clearing a document jam 69
 Adjusting the feeder pressure 70
 Removing the handset cradle 70
 Cleaning the inside of the unit 71

General Information

FCC information 72
 Limited warranty 73
 Service center directory 74
 Information for users 75
 Accessory order information 75
 Specifications 76
 Speed dialer list 77
 Index 79

Location of controls

Front view

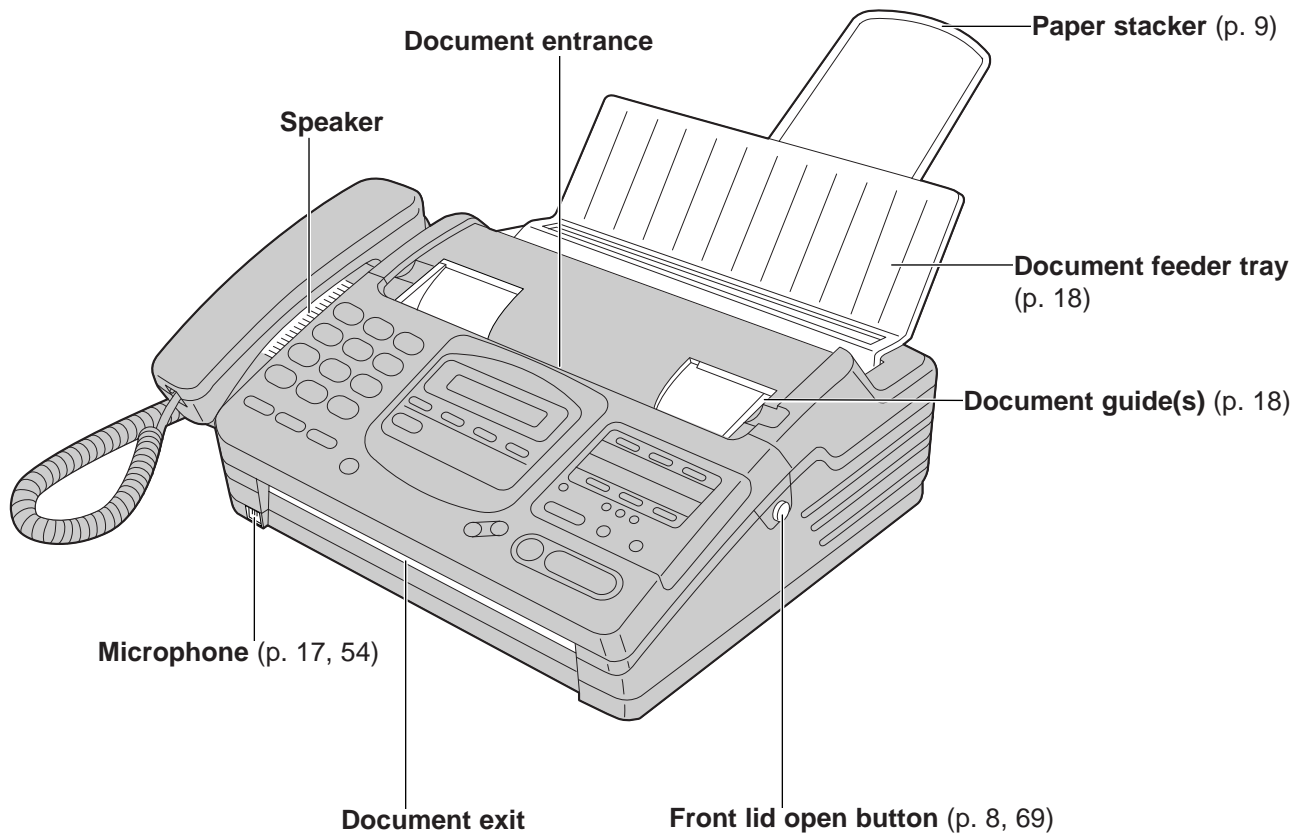

Control panel

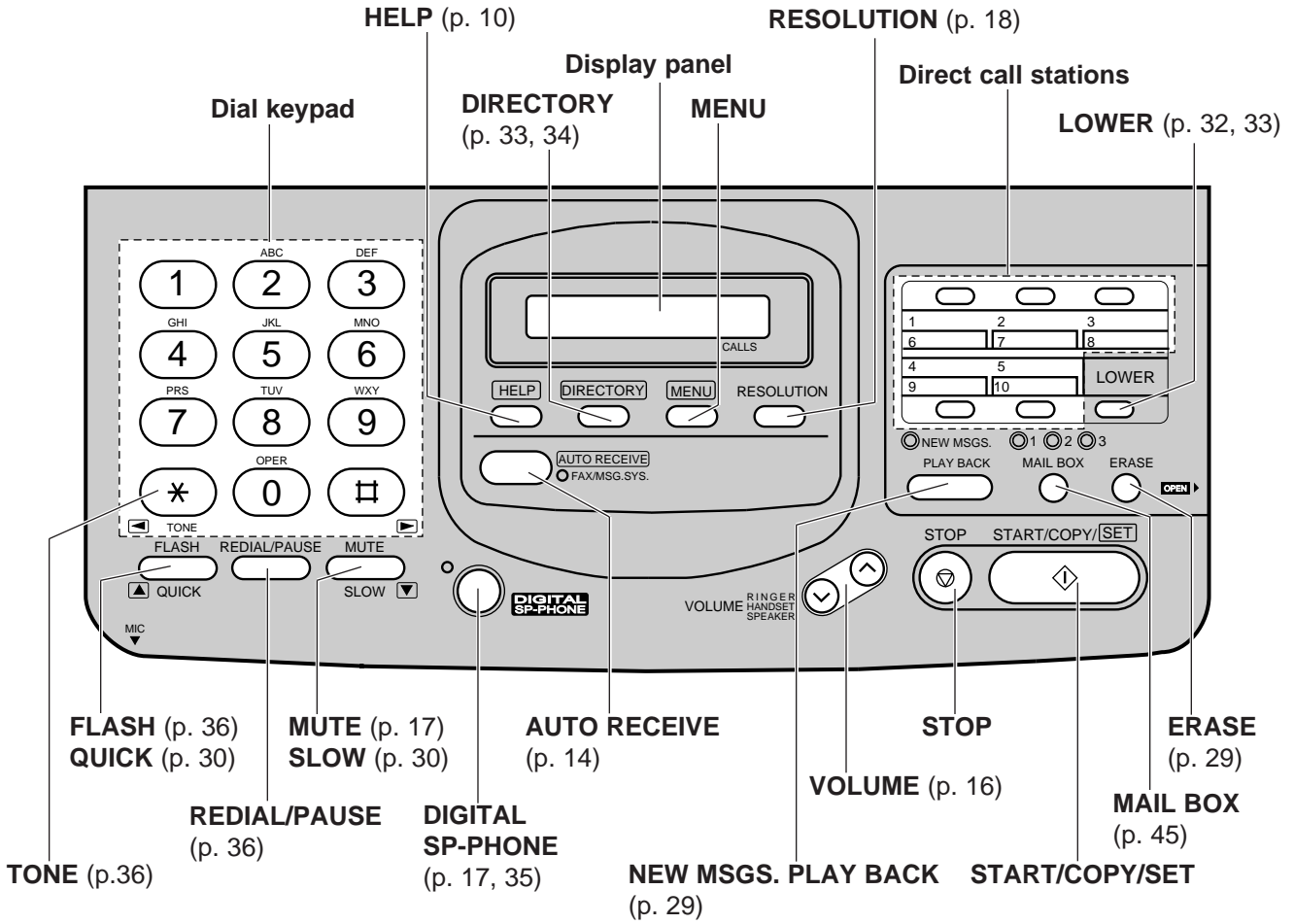

Answering control buttons

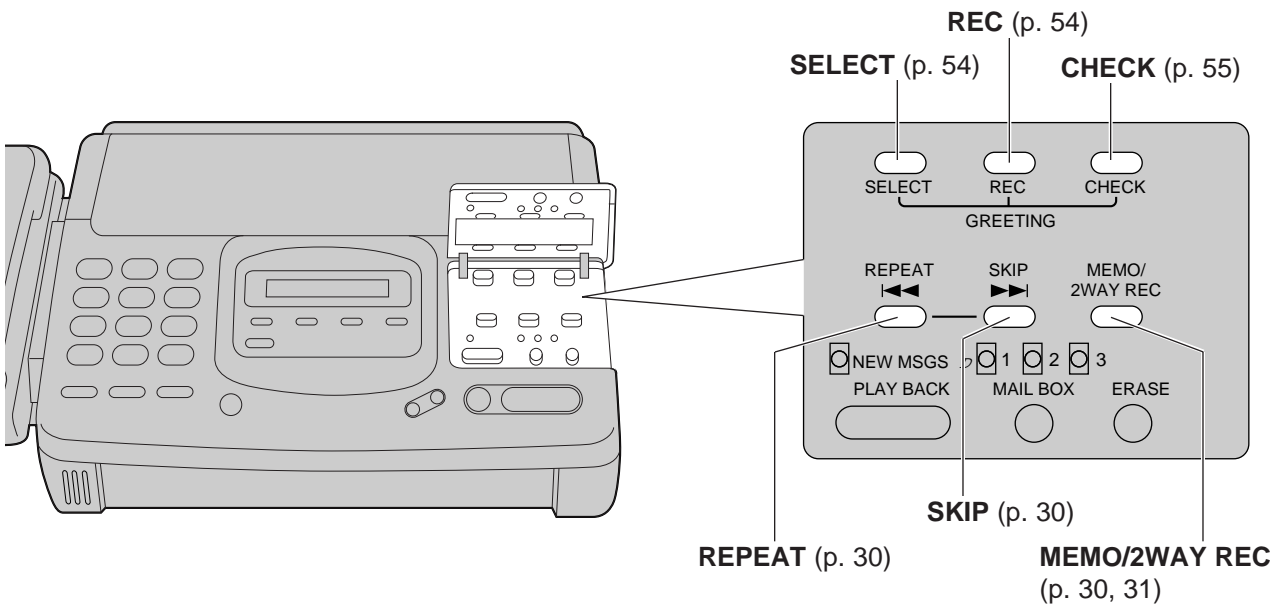

Installing your unit

Installing the handset cradle

If you want to use this unit with a handset, install the handset and handset cradle.

- To save space or to use the unit mainly for faxes, you may remove the handset cradle.

Even if the handset and handset cradle are not installed, you can make or answer calls using the SP-PHONE button. When you don't use the handset and handset cradle, see pages 60 and 70.

1 Connect the handset cord.

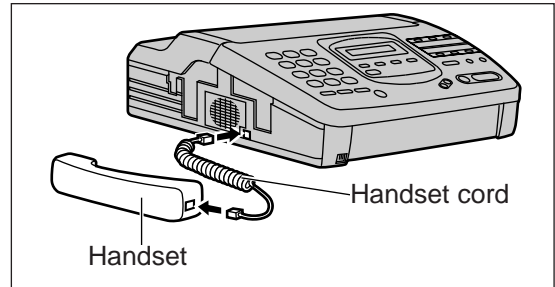

2 (A) Open the front lid by pressing the front lid open button.
(B) Open the back lid by lifting up the tabs located on both sides.

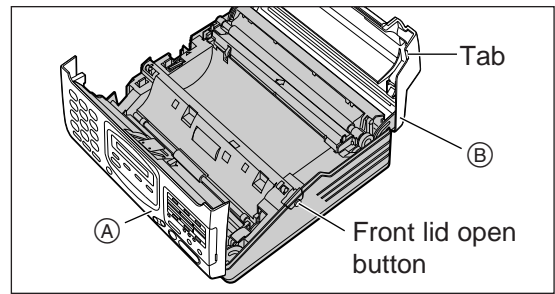

3 Insert the handset cradle by matching the triangles.

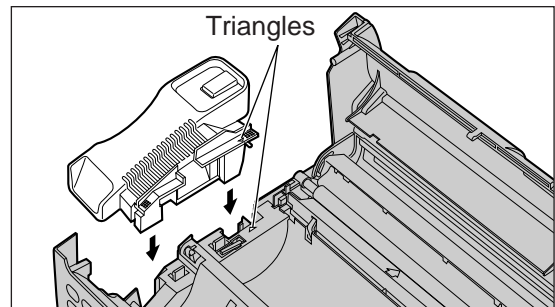

4 Press down on the  marked on the handset cradle until it clicks into place.
•Make sure the two hooks lock the handset cradle firmly.

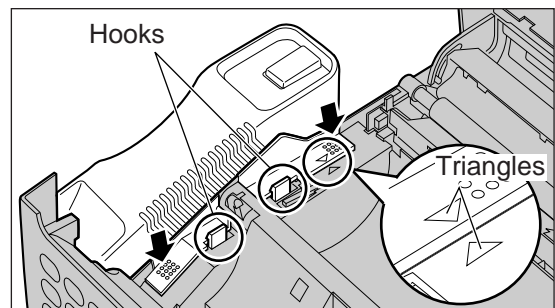

5 Place the handset on the handset cradle and close the lids securely.
•If the following message is displayed when the unit is turned on, the handset cradle is not installed correctly.

CHECK CRADLE

Check step 4 again.

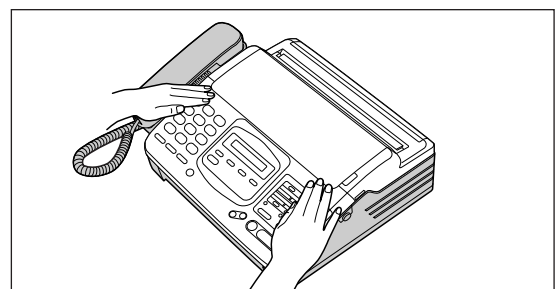

Installing the recording paper

- 1
 - (A) Open the back lid by lifting up the tabs located on both sides.
 - (B) Install a recording paper roll in the unit.
 - Make sure that the shiny side of the paper is facing down and there is no slack, tape, or glue residue on the paper roll.

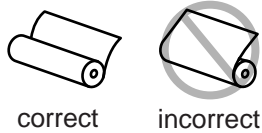

- 2 Insert the leading edge of the recording paper between the recording paper roller and the silver plate.

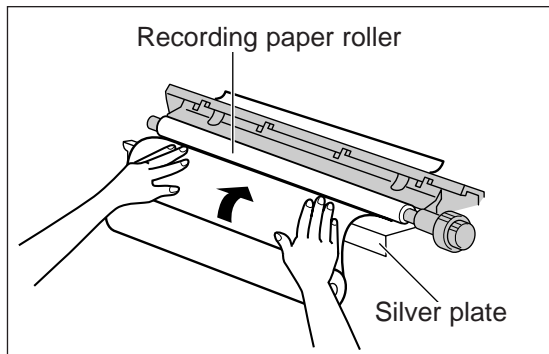
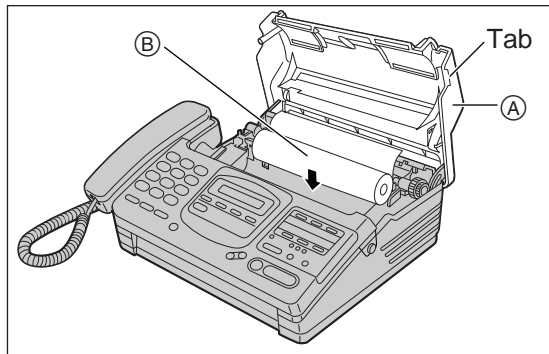

- 3 Close the back lid by gently pressing down on both ends.

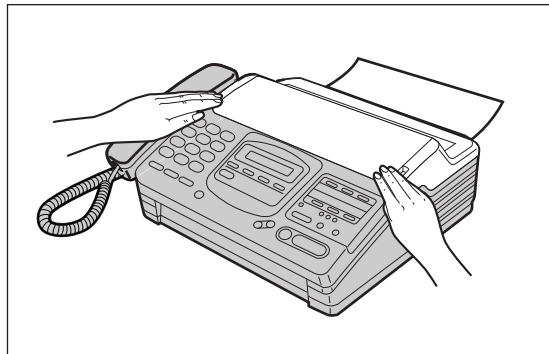

Note:

- Only use the included roll of paper or specified recording paper, or else the print quality may be affected and/or excessive thermal head wear may occur.
- The beginning of some recording paper rolls are secured with glue or tape. Cut approximately 150 mm (6 inches) from the new roll of paper prior to installation.
- To order recording paper, see page 75.

Installing the paper stacker

Install the paper stacker.

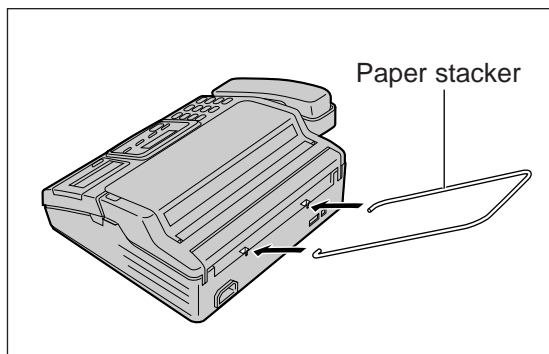

Connections

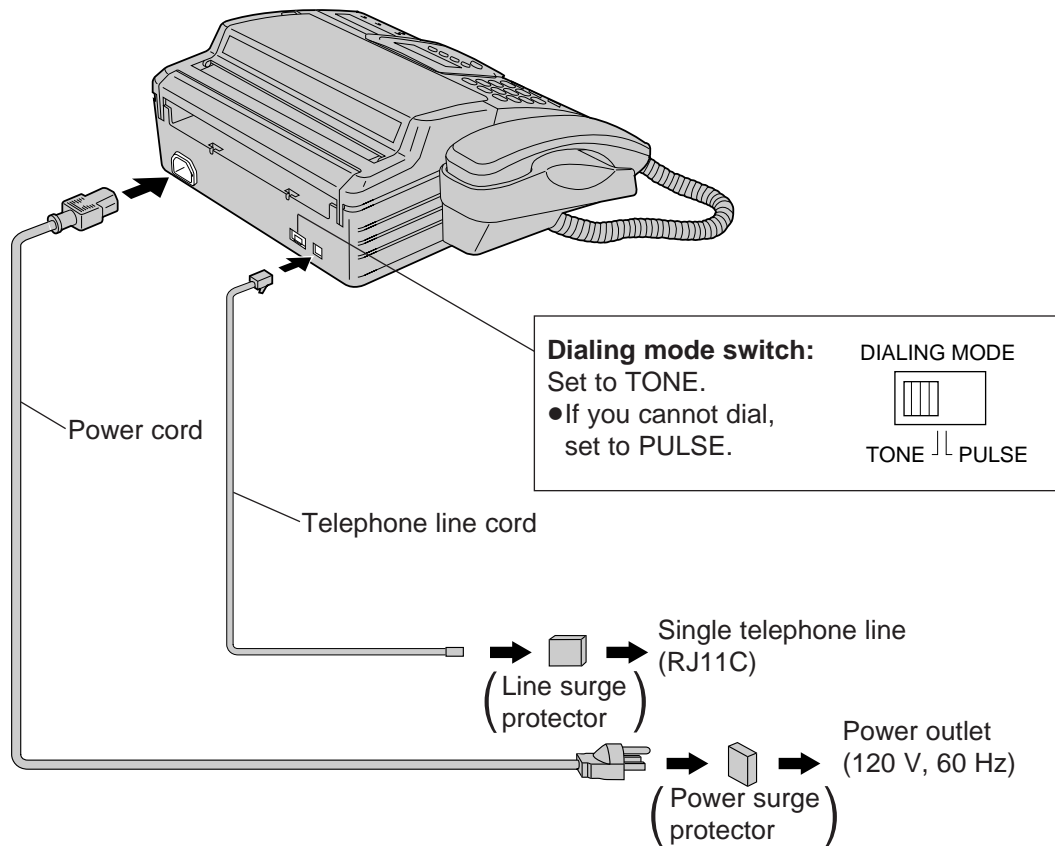

Note:

- For additional equipment protection, we recommend the use of a surge protector. The following types are available; TELESPIKE BLOK MODEL TSB (TRIPPE MFG. CO.), SPIKE BLOK MODEL SK6-0 (TRIPPE MFG. CO.), SUPER MAX (PANAMAX) or MP1 (ITW LINX).
- When you operate this product, the power outlet should be near the product and easily accessible.

Helpful hint:

- If assistance is needed, press **HELP**. The unit will print a quick reference.

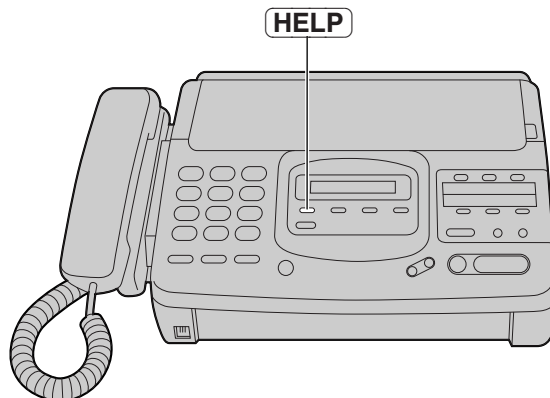



Setting the date, time, logo and facsimile telephone number

Before using your unit, program the correct date and time, your logo and your facsimile telephone number.

This information will be printed on the top of each page transmitted from your unit.
To change the print position, see page 58.

Setting the date and time

- 1 Press **MENU**.

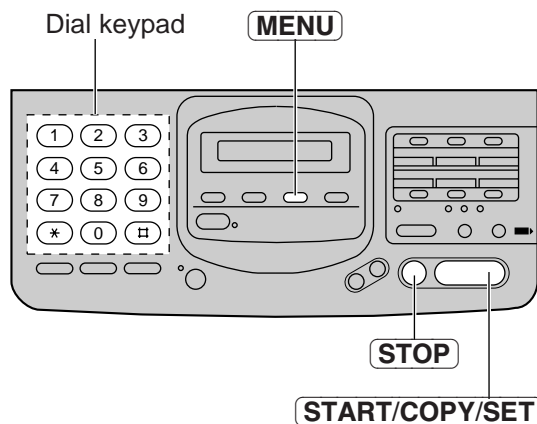
- 2 Press **#**, then **0** **1**.

- 3 Press **START/COPY/SET**.
- 4 Enter the correct month/day/year/hour/minute by selecting each 2 digits.
Then press ***** for AM or **#** for PM.
Example: Aug. 10 1996, 3:00PM
Press **08 10 96 03 00**,
then press **#** for PM.
- 5 Press **START/COPY/SET**.
- 6 Press **MENU**.



Note:

- If you make a mistake while programming, press **STOP** then make corrections.
- The accuracy of the clock will be approximately ± 60 seconds a month.

Setting your logo

Usually the logo is a company, division or personal name in an abbreviated form.

1 Press **MENU**.

SYSTEM SET UP

2 Press **#**, then **0** **2**.

YOUR LOGO

3 Press **START/COPY/SET**.

LOGO=

4 Enter your logo up to 30 characters.
•Refer to the instructions on page 13.

5 Press **START/COPY/SET**.

6 Press **MENU**.

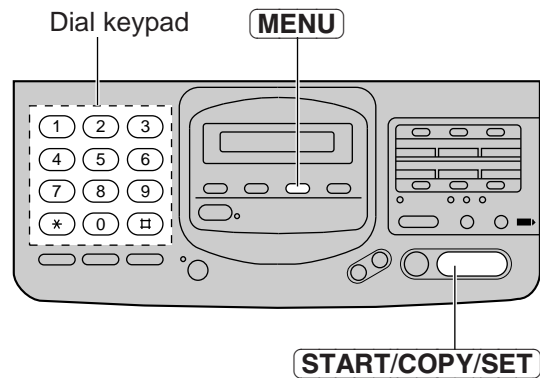

Setting your facsimile telephone number

1 Press **MENU**.

SYSTEM SET UP

2 Press **#**, then **0** **3**.

YOUR TEL NO.

3 Press **START/COPY/SET**.

NO. =

4 Enter your facsimile telephone number up to 20 digits.
•The **#** button inserts a space and the ***** button a "+".
•If you make a mistake, press **STOP** to delete the wrong number to the left of the cursor.





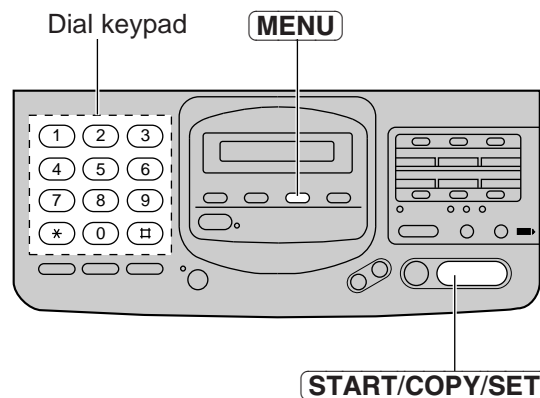











5 Press **START/COPY/SET**.

6 Press **MENU**.



How to enter characters and symbols

The dial keypad and the direct call stations can be used as character input keys and command keys. Pressing 0–9 and direct call station 1 will alternately select a character as shown below.

Keys	Number of times												
	1	2	3	4	5	6	7	8	9	10	11	12	13
	1	[]	{	}	+	-	/	=	,	.	_	'
	A	B	C	a	b	c	2						
	D	E	F	d	e	f	3						
	G	H	I	g	h	i	4						
	J	K	L	j	k	l	5						
	M	N	O	m	n	o	6						
	P	Q	R	S	p	q	r	s	7				
	T	U	V	t	u	v	8						
	W	X	Y	Z	w	x	y	z	9				
	0	()	<	>	!	"	#	\$	%	&	¥	
	:	;	?		*	@	^	'	→				
	INSERT key (Used to insert one character or one space.)												
	SPACE key (Used to replace one character with a space.)												
	DELETE key (Used to delete one character.)												
	▶ key (Used to move the cursor to the right.)												
	◀ key (Used to move the cursor to the left.)												

For example, when entering “Mike” as your logo:

1 Press **6**.

LOGO=M

2 Press **4** six times.

LOGO=Mi

3 Press **5** five times.

LOGO=Mik

4 Press **3** five times.

LOGO=Mike

Note:

- If you use the same number key continuously to enter the next character, press **#** to move the cursor.

To correct a mistake while programming

Use **#** and ***** to move the cursor to the incorrect character, then make the correction.

or

Press **STOP** to delete the character to the left of the cursor.

To see the layout of the direct call station keys

Remove the directory card cover with a pencil or similar object and turn the directory card over.

Selecting the receive mode

The unit combines the functions of facsimile, telephone and answering system.

This unit has two types of receive modes; AUTO RECEIVE and MANUAL RECEIVE.

—When you are unable to answer, set the AUTO RECEIVE mode.

—When you are available, set the MANUAL RECEIVE mode.

Press **AUTO RECEIVE** to switch to the desired mode.

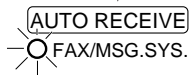
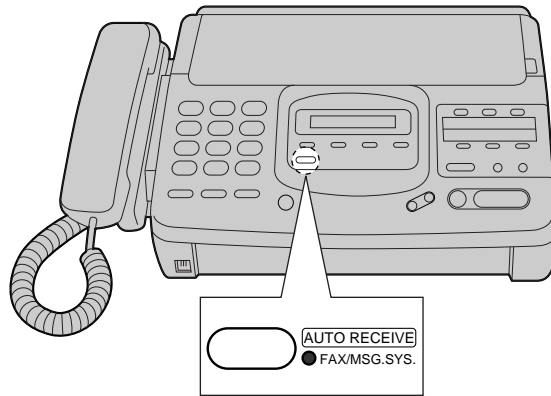

■ AUTO RECEIVE mode

The FAX/MSG.SYS. indicator light goes on.

ANS/FAX mode: (pre-selected setting)
Select this mode when you want the unit to record voice messages and/or receive fax messages (see pages 22 and 23).

Display: ANS/FAX MODE



- You can select the FAX mode instead of the ANS/FAX mode as an AUTO RECEIVE mode (page 15).

FAX mode:
Select this mode when you use the unit solely as a fax machine (see page 24).

Display: FAX MODE

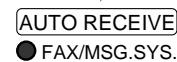

■ MANUAL RECEIVE mode

The FAX/MSG.SYS. indicator light goes off.

TEL mode: (pre-selected setting)
Select this mode when you wish to answer all calls manually.

Display: TEL MODE

- You can change to the ANS/FAX mode from a remote location. Call your unit from a touch tone phone and wait for 15 rings. The answering system will temporarily answer the line. Then enter the remote operation ID (page 50) during the greeting message. The unit will switch to the ANS/FAX mode.



- You can select the TEL/FAX mode instead of the TEL mode as a MANUAL RECEIVE mode (page 15).

TEL/FAX mode:
Select this mode when you are near the unit and do not want to hear the unit ring when faxes are received but wish to answer voice calls (see pages 25, 26 and 27).

Display: TEL/FAX MODE

Note:

- Regardless of the mode you select, you can always place calls and faxes.

Changing the setting of the AUTO RECEIVE mode

You can select either ANS/FAX mode (pre-selected setting) or FAX mode in the AUTO RECEIVE mode. If you want to change the setting, follow the steps below.

- 1 Press **MENU**.

SYSTEM SET UP
- 2 Press **#**, then **0** **5**.

AUTO RECEIVE
- 3 Press **START/COPY/SET**.

MODE=ANS / FAX [▲▼]
- 4 Press **▲** or **▼** to select the desired setting.
- 5 Press **START/COPY/SET**.
- 6 Press **MENU**.

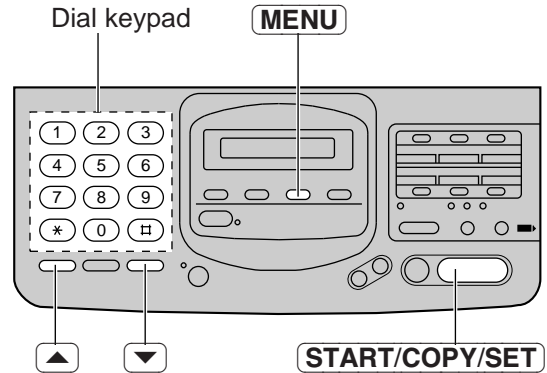

Changing the setting of the MANUAL RECEIVE mode

You can select either TEL mode (pre-selected setting) or TEL/FAX mode in the MANUAL RECEIVE mode. If you want to change the setting, follow the steps below.

- 1 Press **MENU**.

SYSTEM SET UP
- 2 Press **#**, then **0** **8**.

MANUAL RECEIVE
- 3 Press **START/COPY/SET**.

MODE=TEL [▲▼]
- 4 Press **▲** or **▼** to select the desired setting.
- 5 Press **START/COPY/SET**.
- 6 Press **MENU**.

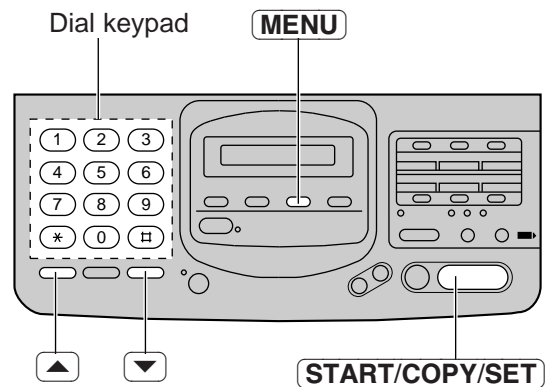

Adjusting volumes

■ Ringer volume

Press **VOLUME** (∨/∧) while the unit is idle.
●3 levels (high/low/off) are available.

To turn the ringer off:

1. Press **VOLUME** (∨) repeatedly.
 - The following message will be shown.

RINGER OFF= OK?

2. Press **START/COPY/SET**.

While the ringer volume is set to off:

The display will show the following message and the unit will not ring when receiving a call.

RINGER OFF

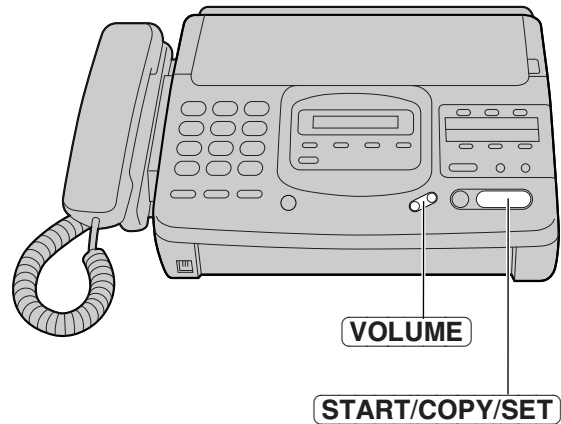

■ Handset volume

Press **VOLUME** (∨/∧) while using the handset.
●3 levels (high/middle/low) are available.

■ Speaker volume

Press **VOLUME** (∨/∧) while using the speakerphone.
●8 levels (high to low) are available.

■ Answering device volume

Press **VOLUME** (∨/∧) while listening to recorded messages.
●9 levels (high to off) are available.

■ Fax voice guidance volume

Press **VOLUME** (∨/∧) while listening to the voice guidance.
●9 levels (high to off) are available.

Making voice calls

- 1 Press **DIGITAL SP-PHONE** or lift the handset.
- 2 Dial a phone number.
 - If you misdial, hang up and dial again.
- 3 When the other party answers, speak into the microphone or handset.
- 4 When finished, press **DIGITAL SP-PHONE** again or hang up the handset.

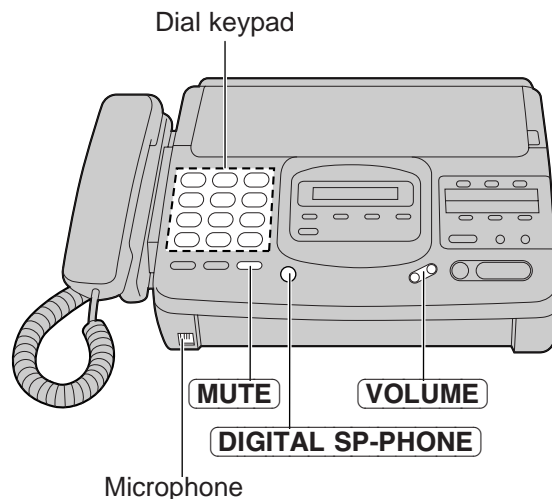

Answering voice calls

- 1 When the unit rings, lift the handset or press **DIGITAL SP-PHONE**.
- 2 When finished, hang up the handset or press **DIGITAL SP-PHONE**.

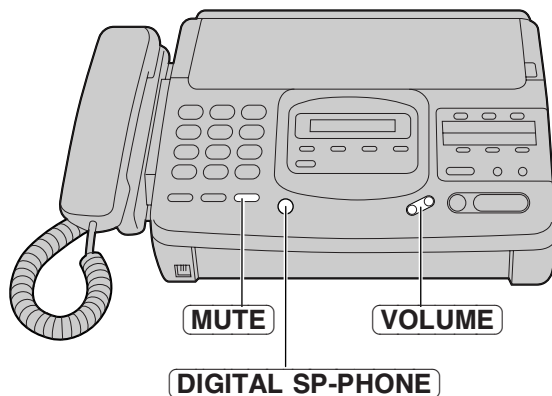

Voice muting

Using this feature, the other party cannot hear you but you can hear them.

1. Press **MUTE** during a telephone conversation.

<MUTE>

2. To resume the conversation, press **MUTE** again.

Hints for speakerphone operation

- Use the speakerphone in a quiet room.
- If the other party has difficulty hearing you, adjust the volume using **VOLUME**.
- If you and the other party speak at the same time, parts of your conversation will be lost.
- To switch to the handset, lift the handset. To switch back to the speakerphone again, press **DIGITAL SP-PHONE**.

Transmitting documents

Documents you can send

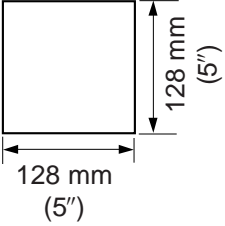
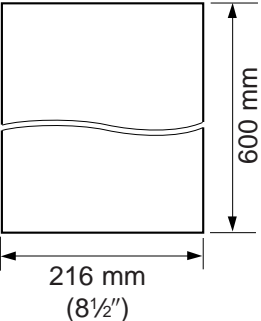
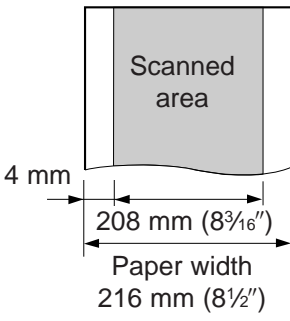
Minimum size	Maximum size	Effective scanning area	Document weight
 <p>128 mm (5") 128 mm (5")</p>	 <p>216 mm (8 1/2") 600 mm (23 5/8")</p>	 <p>4 mm 208 mm (8 3/16") Paper width 216 mm (8 1/2")</p>	<p>Single sheet: 45 to 90 g/m² (12 to 24 lb.) Multiple sheets: 60 to 75 g/m² (16 to 20 lb.)</p>

Note:

- Remove clips, staples or other similar fastening objects.
- Check that ink, paste or correction fluid has dried.
- Do not send the following types of documents. Use copies for fax transmission.
 - Chemically treated paper such as carbon or carbonless duplicating paper
 - Electrostatically charged paper
 - Heavily curled, creased or torn paper
 - Paper with a coated surface
 - Paper with a faint image
 - Paper with printing on the opposite side that can be seen through the front (e.g. newspaper)

Loading documents

- 1 Open the document feeder tray.
- 2 Insert the documents **FACE DOWN** until a beep tone is heard.
 - The unit can accept up to 15 sheets of paper at a time.
- 3 Adjust the document guides to the width of the document.
- 4 Press **RESOLUTION** repeatedly to the desired setting.

STANDARD	For printed or typewritten originals with normal-sized characters.
FINE	For originals with small printing.
SUPER FINE	For originals with minute printing.
HALF TONE	For originals containing photographs, shaded drawings, etc.

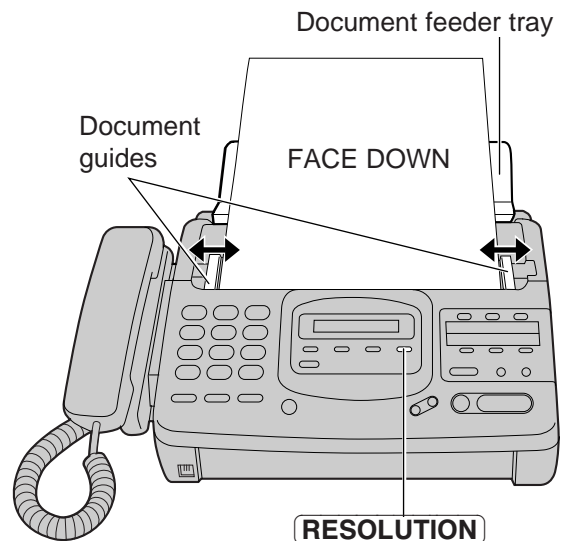

Note:

- Using the fine, super fine or half tone setting will increase transmission time.
- If the resolution setting is changed during feeding, it will be effective from the next sheet.
- The super fine resolution only works with other compatible machines.

Transmitting documents manually

- 1 Insert the documents **FACE DOWN** until a beep tone is heard.
- 2 Press **DIGITAL SP-PHONE** or lift the handset.
- 3 Dial a phone number.
 - If you misdial, hang up and dial again.
- 4 When a fax tone is heard, press **START/COPY/SET**.
- 5 Hang up the handset if using it.

Note:

- If the other party answers your call, ask them to start receiving a fax, then press your **START/COPY/SET**.
- The unit will automatically end the transmission after the last sheet is transmitted.

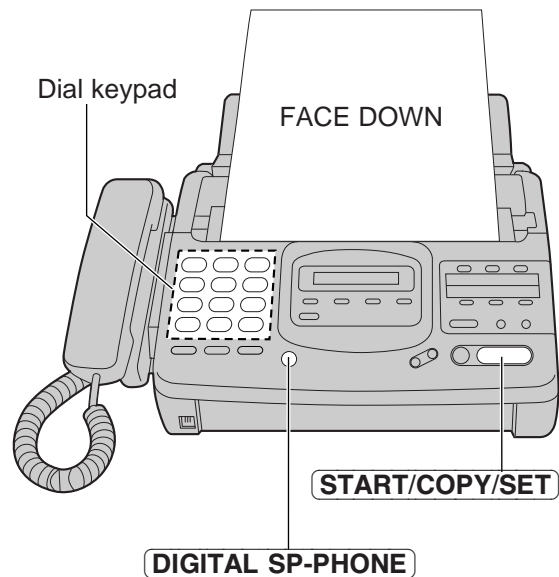

Transmitting documents with fewer procedures

- 1 Insert the documents **FACE DOWN** until a beep tone is heard.
- 2 Dial a phone number.
 - If you misdial, press **STOP** and dial again.
- 3 Press **START/COPY/SET**.
 - The unit will start to dial and transmit the documents.

Fax Auto Redial

- If there is no answer or the line is busy, the unit will automatically redial the number up to 5 times. This feature is available when you transmit documents with fewer procedures, automatic dialing (p. 33), delayed transmission (p. 38) and receive polling (p. 37). To cancel redialing, press **STOP**.

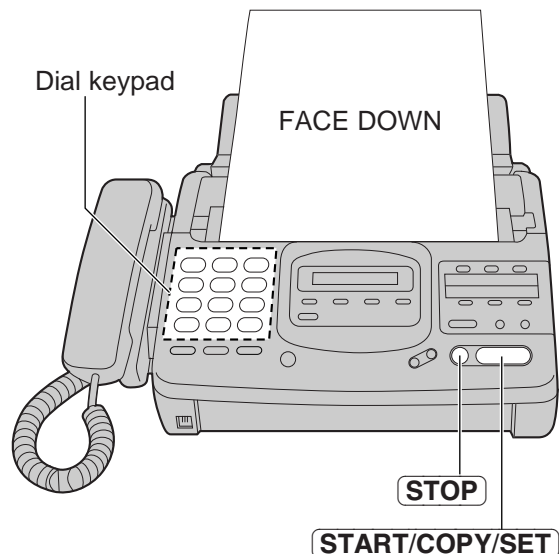

To send 16 or more sheets at a time

Insert the first 15 sheets of the document. Add the extra sheets (up to 15) before the last sheet is fed into the unit.

To stop transmission

Press **STOP**.

- To eject the document, press **STOP** again.

Fax voice guidance about transmission

After transmission, one of the following messages will tell you the result.

- Transmission is complete.*
- Transmission has failed.*

You can set this feature to OFF and the guidance will not be heard (see page 59).

Transmitting documents by following the voice guide

1 Press **MENU** until the following is displayed.

XMT VOICE GUIDE

2 Press **HELP**.

Voice guide:

To transmit, insert the document face down until you hear the beep.

3 Insert the documents FACE DOWN until a beep tone is heard.

Voice guide:

Press the speaker phone button, then dial the phone number. When the fax tone is heard, press the start button.

4 Press **DIGITAL SP-PHONE**.

5 Dial a phone number.

6 When a fax tone is heard, press **START/COPY/SET**.

Voice guide:

Start transmission.

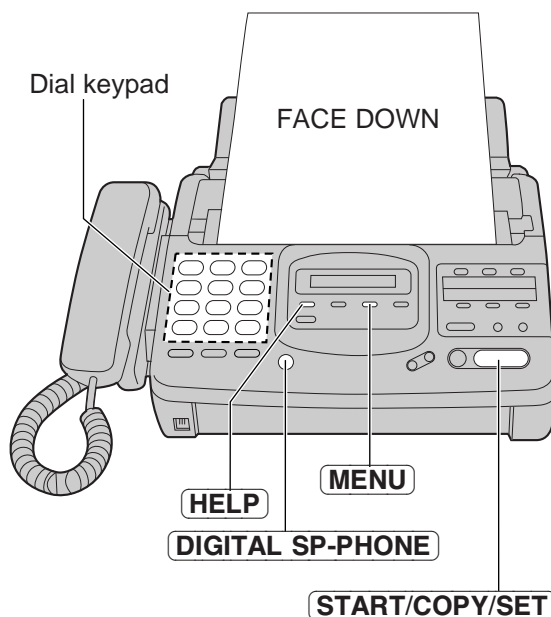

Note:

- You can lift the handset instead of pressing **DIGITAL SP-PHONE** in step 4.

Receiving documents

Receiving fax documents manually

- 1** When the unit rings, lift the handset or press **DIGITAL SP-PHONE** to answer the call.
- 2** When:
 - document reception is required,
 - a slow beep is heard, or
 - no sound is heard,press **START/COPY/SET**.
- 3** Hang up the handset if using it.
 - The recording paper will print out face side down.

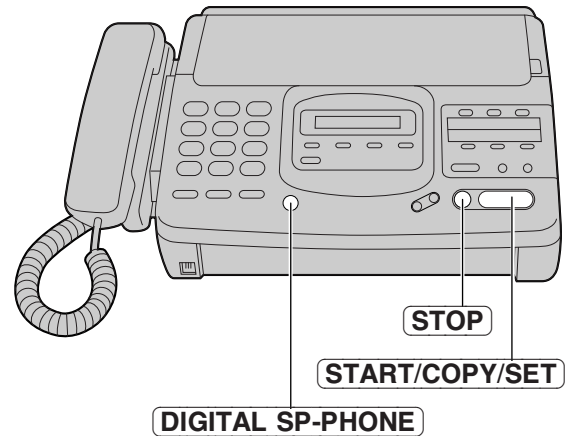

Friendly reception

The unit will automatically start reception even if you don't press **START/COPY/SET** in the following cases:

- when you lift the handset and hear the message "Please hang up the handset for reception.", or
- when you press **DIGITAL SP-PHONE** and hear the message, "Start reception."

- If this feature is not required, set to OFF (see page 59).

Fax voice guidance about reception

After reception, one of the following messages will tell you the result.

- *Reception is complete.*
- *Reception has failed.*
- *Reception has been interrupted.*

- You can set this feature to OFF and the guidance will not be heard (see page 59).

To stop reception

Press **STOP**.

Receiving fax documents and/or recording incoming voice messages automatically (ANS/FAX mode) _____

When you turn on the AUTO RECEIVE mode that is set to ANS/FAX, the unit will work as a facsimile machine and/or answering device.

If a fax call is detected, the unit will automatically switch to the fax and receive fax documents.

If a voice call is detected, the answering system will begin recording, then the caller can leave a voice message.

Setup of voice message and document reception

The total recording time (including the greeting messages) is about 18 minutes. If messages are recorded in noisy rooms, the time may be shortened by 7 minutes.

To record incoming voice messages and receive fax documents, follow these steps:

1 Make sure that the AUTO RECEIVE mode is set to ANS/FAX (see page 15).

2 Turn on the AUTO RECEIVE mode by pressing **AUTO RECEIVE** until the FAX/MSG.SYS. indicator light goes on.

- The display shows the following message.

ANS / FAX MODE

The remaining time for recording incoming messages will be displayed on the display.

Example: TIME LEFT=10m13s

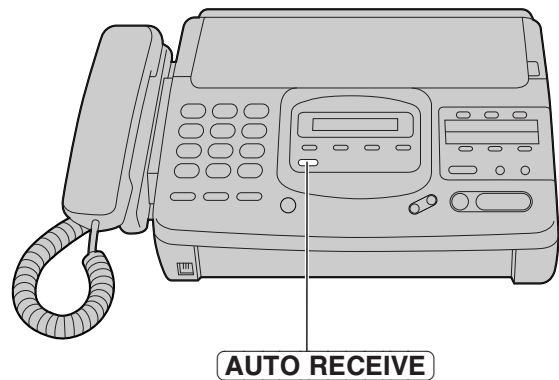

Note:

- You can record your own greeting message (see page 54). If it is not recorded, a pre-recorded greeting message will be played to the caller.
- Each incoming message recording time can be set to either unlimited or 1 minute. To change the setting, see page 56.
- When the remaining time is low, erase unnecessary messages from memory (see pages 29 and 46).

Pre-recorded greeting messages

The unit has four pre-recorded greeting messages in common memory. According to the unit's condition, one of the following messages will be played to the caller.

- When your own greeting message (page 54) is not recorded, the following greeting message will be played.

*Hello! We are unable to answer right now.
To send a fax, please start transmission.
To leave a voice message, please speak after the beep.
Thank you.*

■ When the unit detects a problem, one of the following pre-recorded greeting messages will be played.

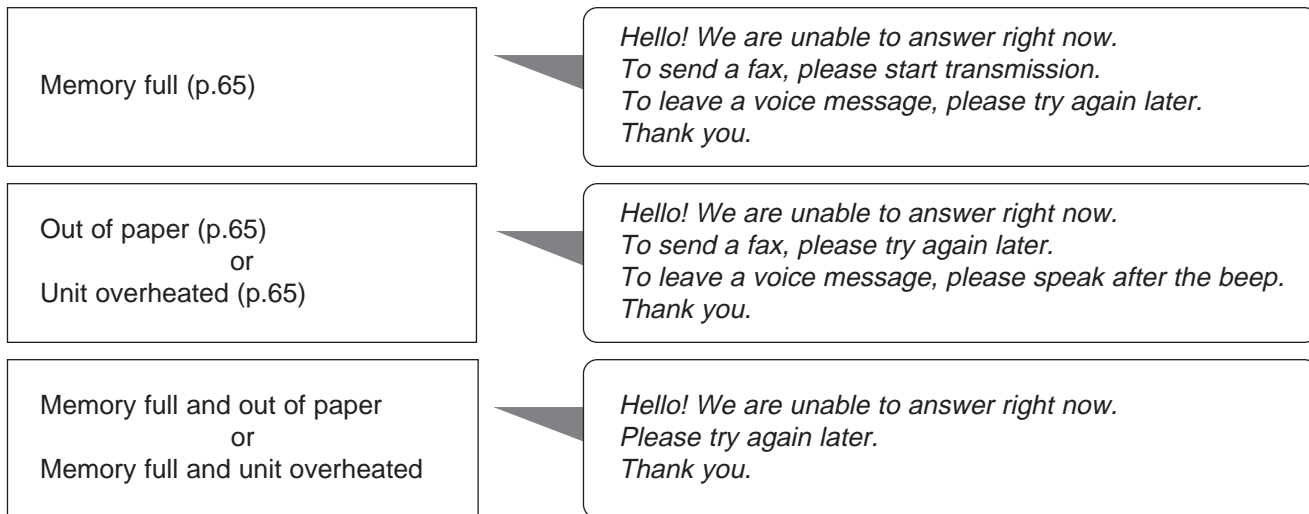

Setting the ANS/FAX mode ring count

This feature determines the number of rings after which the unit answers a call in the ANS/FAX mode. You can choose from 1, 2, 3, 4, TOLL SAVER and RINGER OFF.

TOLL SAVER: When you call the unit from a remote location, the number of rings will tell you if there are any new voice messages. If the unit answers on the first ring, there is at least one new recorded message. If the unit answers on the third ring, there are no new recorded messages. Hang up immediately when you hear the second ring. The second ring indicates that there are no new messages. This will save you the toll charge for the call.

RINGER OFF: The unit will answer without ringing.

Helpful hints:

- To answer a call before the unit does, increase the number of rings.
- If you find difficulty in receiving faxes from machines that have an automatic transmission feature, decrease the number of rings.

- 1 Press **MENU**.
SYSTEM SET UP
- 2 Press **#**, then **0** **6**.
ANS/FAX RING
- 3 Press **START/COPY/SET**.
RING=1 [▲▼]
- 4 Press ▲ or ▼ to select the desired setting.
- 5 Press **START/COPY/SET**.
- 6 Press **MENU**.

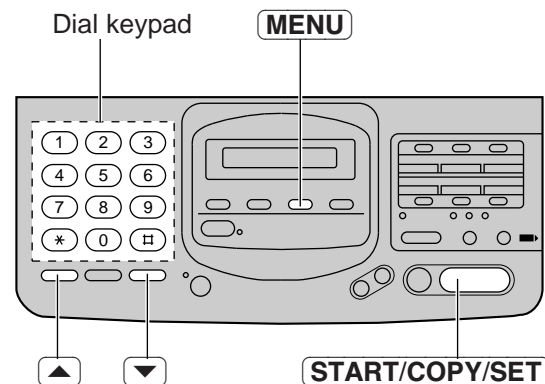

Note:

- If an extension telephone with a caller ID or call display feature is connected to the same line, set the number of rings to more than 2.

Receiving fax documents only (FAX mode)

When you turn on the AUTO RECEIVE mode that is set to FAX, the unit will work as a dedicated facsimile machine.

The unit will automatically answer all calls and generate fax tones to the callers. Callers will hear fax tones and will only be able to transmit faxes.

Setting up the unit for fax reception

- 1 Set the AUTO RECEIVE mode to FAX (see page 15).
- 2 Turn on the AUTO RECEIVE mode by pressing **AUTO RECEIVE** until the FAX/MSG.SYS. indicator light goes on.
 - The display shows the following message.

FAX MODE

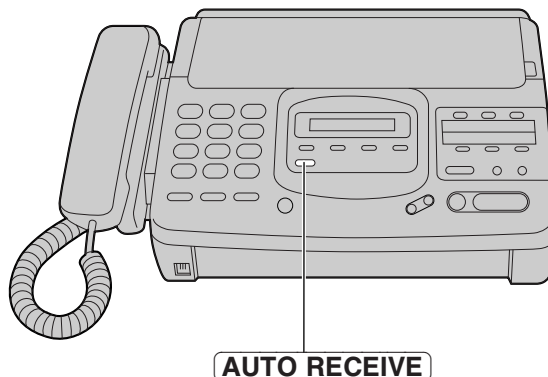

Setting the FAX mode ring count

This feature determines the number of rings after which the unit answers a call in the FAX mode. You can choose from 1 to 4 rings.

Helpful hints:

- To answer a call before the unit does, increase the number of rings.
- If you find receiving faxes from machines with an automatic transmission feature difficult, decrease the number of rings.

- 1 Press **MENU**.
SYSTEM SET UP
- 2 Press **#**, then **0** **7**.
FAX RING
- 3 Press **START/COPY/SET**.
RING=1 [▲▼]
- 4 Press **▲** or **▼** to select the desired number.
- 5 Press **START/COPY/SET**.
- 6 Press **MENU**.

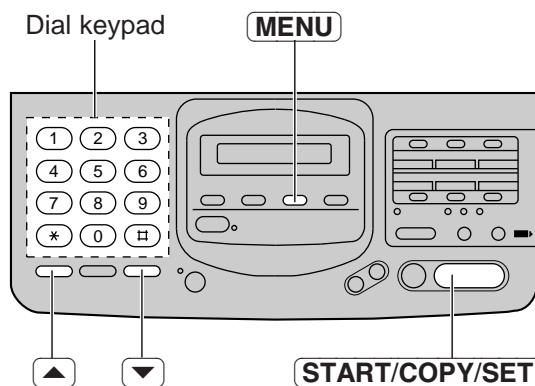

Note:

- If an extension telephone with a caller ID or call display feature is connected to the same line, set the number of rings to more than 2.

Receiving both voice and fax calls (TEL/FAX mode)

Use this mode when you wish to receive voice calls with ring but do not want to hear the unit ring when faxes are received.

When a call is received, the unit will work as follows.

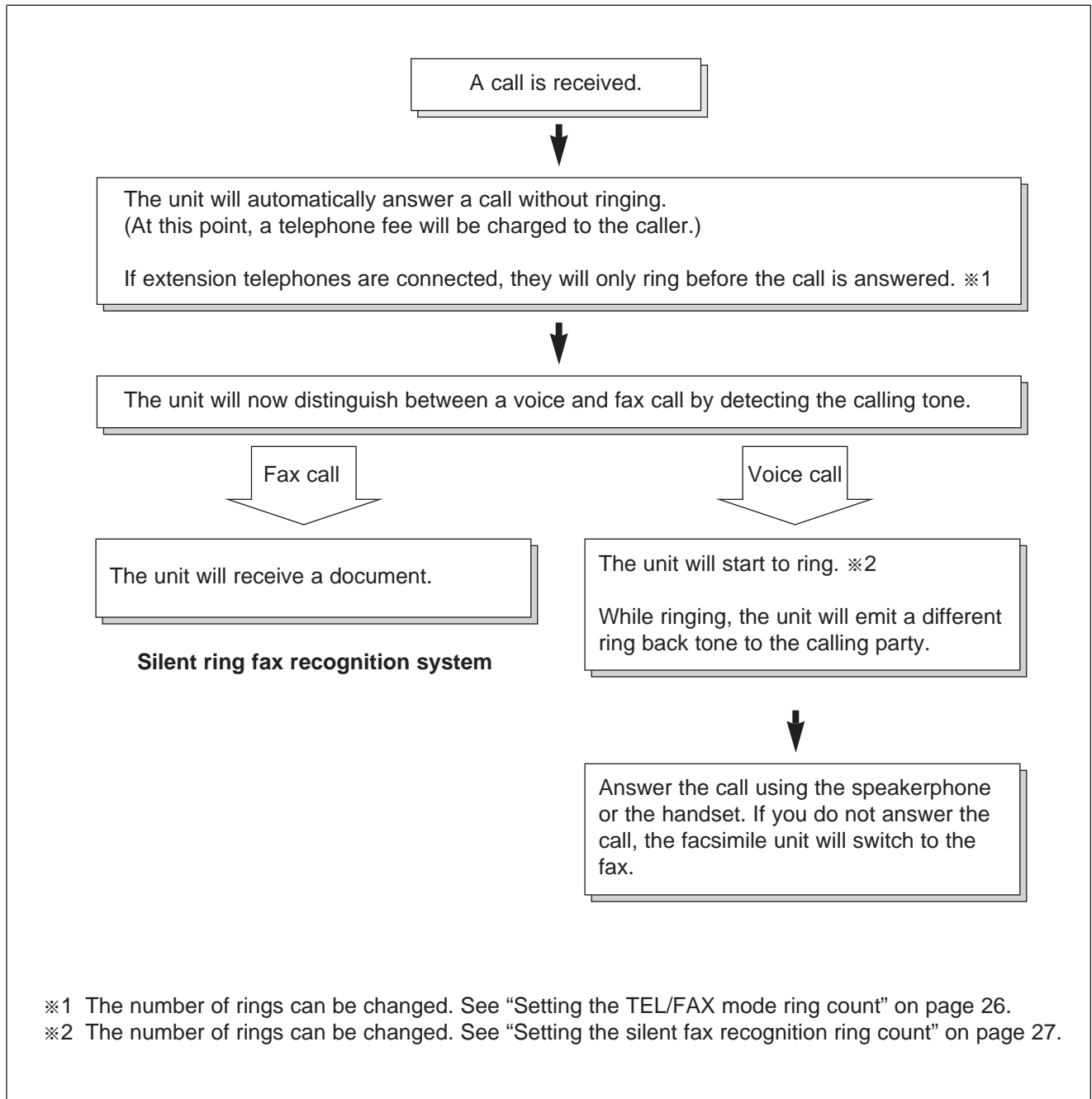

Note:

- Some fax messages that are transmitted manually may not send a calling tone. These calls must be manually received.
- You can record the TEL/FAX greeting message (see page 54).

Setting up the unit

- 1 Record the TEL/FAX mode greeting message (see page 54).
 - The TEL/FAX mode greeting message will be played to the caller when the unit automatically answers the incoming call.
- 2 Set the MANUAL RECEIVE mode to TEL/FAX (see page 15).
- 3 Make sure that the AUTO RECEIVE mode is turned off.
 - If the FAX/MSG. SYS. indicator light is on, press **AUTO RECEIVE** to turn off the AUTO RECEIVE mode.

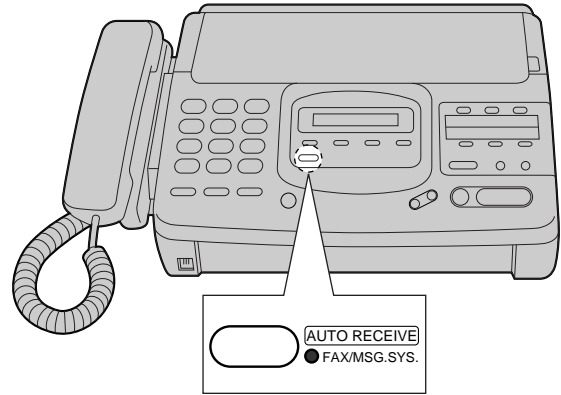

Setting the TEL/FAX mode ring count

This feature determines the number of rings after which the unit automatically answers a call in the TEL/FAX mode.

You can choose from 1 to 4 rings.

- 1 Press **MENU**.
SYSTEM SET UP
- 2 Press **#**, then **0** **9**.
TEL/FAX RING
- 3 Press **START/COPY/SET**.
RING=1 [▲▼]
- 4 Press **▲** or **▼** to select the desired number.
- 5 Press **START/COPY/SET**.
- 6 Press **MENU**.

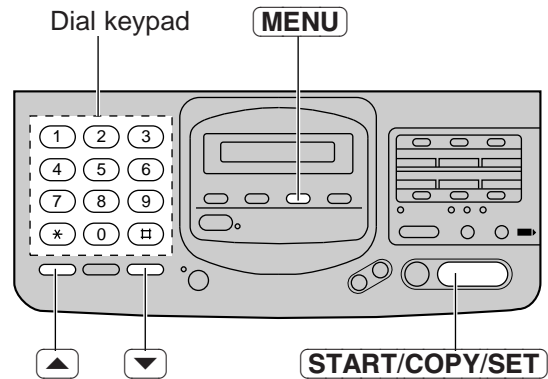



Note:

- If an extension telephone with a caller ID or call display feature is connected to the same line, set the number of rings to more than 2.

Setting the silent fax recognition ring count

When a fax call is received in the TEL/FAX mode, the unit will automatically activate the fax function without ringing. If the unit detects a voice call, it will ring. You can choose from 3 to 6 rings.

- 1** Press **MENU**.

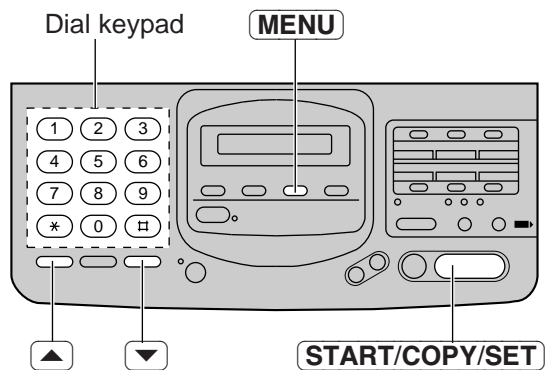
- 2** Press **#**, then **3** **0**.

- 3** Press **START/COPY/SET**.

- 4** Press **▲** or **▼** to select the desired number.
- 5** Press **START/COPY/SET**.
- 6** Press **MENU**.



Making a copy

Any transmittable document can be copied (see page 18).

1 Insert the documents (up to 15 sheets) FACE DOWN until a beep tone is heard.

2 Press **START/COPY/SET**.

Note:

- When copying, the unit will automatically select FINE resolution. To change the resolution, press **RESOLUTION**.
- You can make or receive a voice call while making a copy.

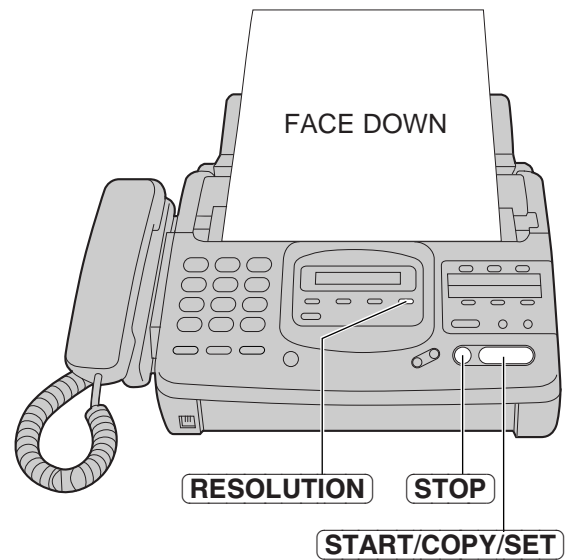

To stop copying

Press **STOP**.

Operating the answering device

Listening to messages in common memory

When the unit receives voice messages;
—the NEW MSGS. indicator will flash,
—the call counter will show the total number of recorded messages, and
—a slow beep will sound if message alert (page 56) is set to ON.

■ Listening to new recorded messages

Press **NEW MSGS. PLAY BACK** lightly.

■ Listening to all of the recorded messages

Press **NEW MSGS. PLAY BACK** firmly until a beep is heard.

Note:

- During playback, the display shows the recorded order of the messages.
- Adjust the speaker volume using **VOLUME**.

Voice time/day stamp:

During playback, a synthesized voice will announce the time and day when each message was recorded.

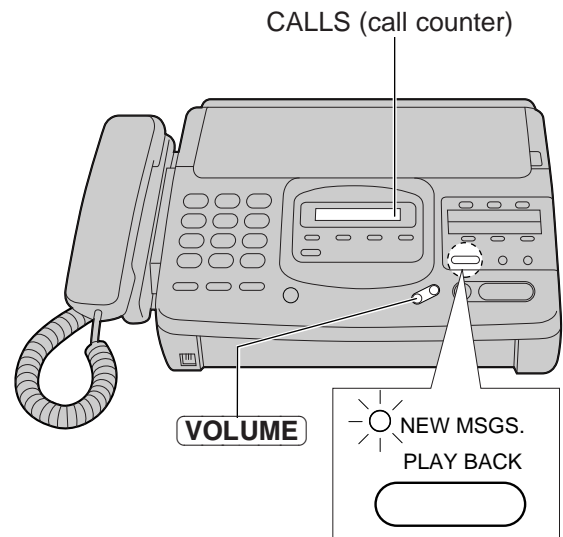

Erasing recorded messages

■ Erasing specific messages from memory:

Press **ERASE** when the message you want to erase is playing.

■ Erasing all messages in common memory:

1. Press **ERASE** after listening to all of the messages.

ICM ERASE OK?

- To cancel erasing, press **STOP**.

2. Press **START/COPY/SET**.

ERASE COMPLETED

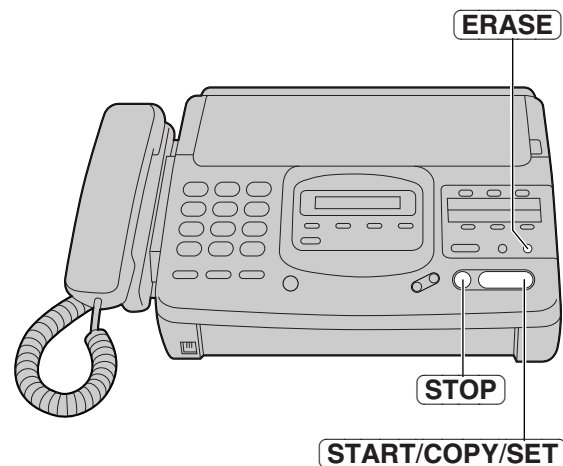

Functions during playback

■ Repeating a message:

Press **REPEAT** while the message you want to listen to is playing.

- If you press **REPEAT** within 5 seconds of the beginning of the message, the previous message will be played.
- To play back a specific message, press **REPEAT** repeatedly until the message you want to play back is heard.

■ Skipping a message:

Press **SKIP** to play back the next message.

■ Stopping the operation:

Press **STOP** to stop playing back.

- To resume the playback, press **NEW MSGS. PLAY BACK** within 1 minute after pressing **STOP**.

■ Changing the playback speed:

Press **QUICK** to play back messages at one and a half times the original speed.

Press **SLOW** to play back messages at a half the original speed.

To return to the original speed:

Press **QUICK** or **SLOW** again during quick or slow playback.

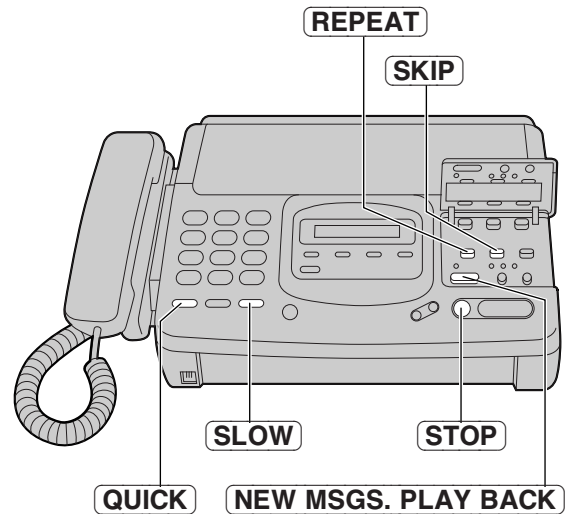

Recording a memo message

If you are going out and want to leave a private message for someone, you can record a voice memo in the unit. This can be played back later, either directly or remotely, like other messages.

- 1 Open the station key panel.
- 2 Press **MEMO/2WAY REC**.
 - A long beep will sound.
- 3 Speak clearly into the microphone.
- 4 When finished, press **STOP**.

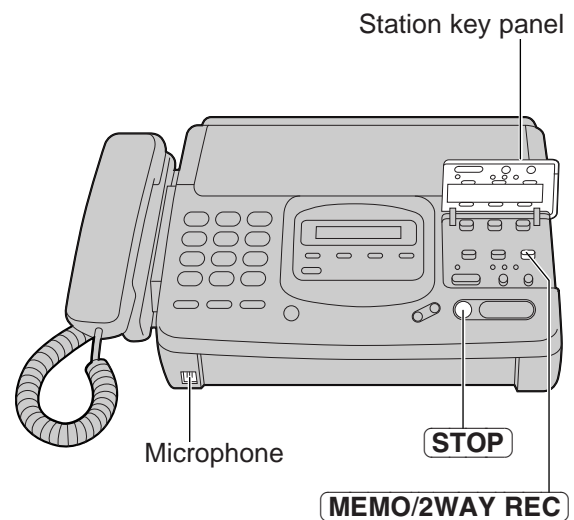

Recording a telephone conversation

While you are talking with the handset, the telephone conversation can be recorded.

1 During a telephone conversation, open the station key panel.

2 Press **MEMO/2WAY REC**.

2WAY RECORDING

3 To stop recording, press **STOP** or hang up.

Note:

- There may be regulations in your area (state) concerning the manner in which 2-way telephone conversations may be recorded. You should inform the other party that the conversation is being recorded. Consult your local telephone company for further information.

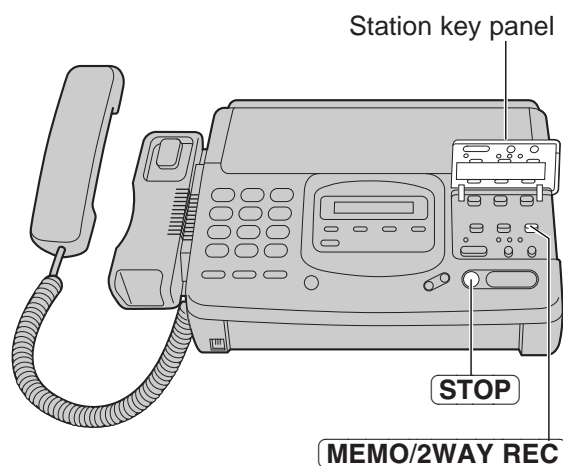

Storing phone numbers for automatic dialing

The unit's memory allows you to use both one-touch dialing and speed dialing for rapid access to your most frequently dialed numbers.

One-touch dialing: The unit is equipped with 5 direct call station keys, each of which is divided into an upper station and a lower station.

Speed dialing: The unit is equipped with 50 additional dialing stations. These stations are assigned to 2-digit numbers (00–49).

1 Press **MENU** until the following message is displayed.

STORE TEL NO.

**2 a: Programming for one-touch dialing:
For upper stations (1–5)**

Press one of the direct call station keys.

For lower stations (6–10)

Press **LOWER**, then press one of the direct call station keys.

b: Programming for speed dialing:

Press **#**, then press the desired 2-digit number (00–49).

3 Enter the phone number up to 30 digits in length.

- To enter a hyphen in a phone number, press **LOWER**.

4 Press **START/COPY/SET**.

NAME=

5 Enter the station name, up to 10 characters, by following the instructions on page 13.

6 Press **START/COPY/SET**.

- To program other stations, repeat steps 2 to 6.

7 Press **STOP**.

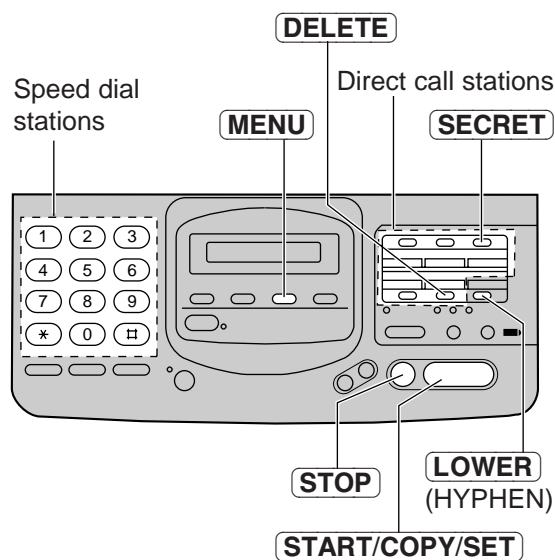

Helpful hint:

- To confirm stored phone numbers and station names, print a telephone number list (see page 62).

To keep whole or part of the phone number secret

Press **SECRET** (direct call station 3) before and after the number you wish to keep secret.

- The phone number will not appear on the display and on the telephone number list.
- Pressing **SECRET** once counts as two digits.

To erase a stored number and station name

Press **STOP** in step 3 to clear the phone number. Press **DELETED** (direct call station 5) repeatedly in step 5 until all of the characters are erased. Then, press **START/COPY/SET**.

Making voice calls using automatic dialing

1 Press **DIGITAL SP-PHONE** or lift the handset.

2 a: Using one-touch dialing:
For upper stations (1–5)
Press the desired direct call station key.

For lower stations (6–10)
Press **LOWER**, then press the desired direct call station key.

b: Using speed dialing:
Press **DIRECTORY**, then press **#** and the desired 2-digit number (00–49).

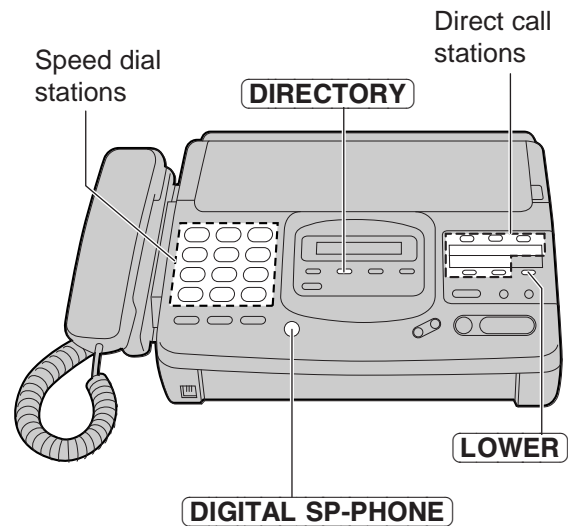

Transmitting documents using automatic dialing

1 Insert the documents FACE DOWN.

2 a: Using one-touch dialing:
For upper stations (1–5)
Press the desired direct call station key.

For lower stations (6–10)
Press **LOWER**, then press the desired direct call station key.

b: Using speed dialing:
Press **DIRECTORY**, then press **#** and the desired 2-digit number (00–49).

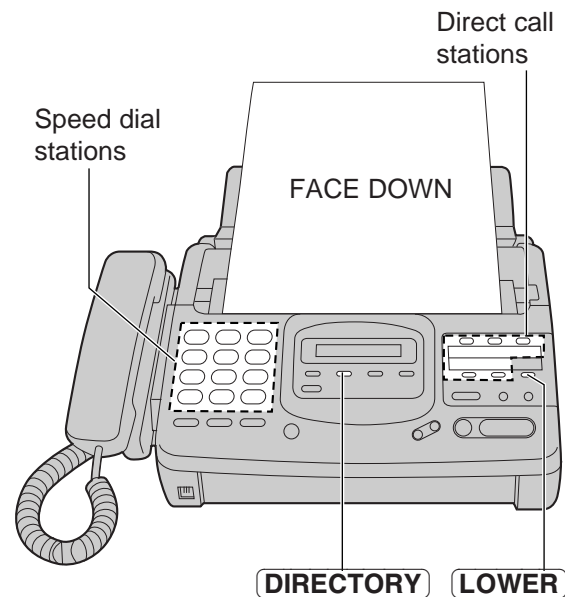

Electronic telephone directory

The station names stored in memory are automatically registered into the electronic telephone directory in alphabetical order. You can make a fax or voice call by selecting the desired station name on the display.

If you wish to send a fax, insert the documents into the document tray first.

1 Press **DIRECTORY**.

SELECT INDEX

2 ■ Press the dial key in which the first initial of the station name is assigned (see index table below).

Example: To search a name with the initial "N":
 Press **6** repeatedly until the first station name with initial "N" is displayed. Press **▼** until the desired name is displayed.

OR

■ Press **▲** or **▼** repeatedly until the desired name is displayed.

3 Press **START/COPY/SET**.

- The unit will start dialing.
- If a document is fed into the unit, the unit will start transmission.

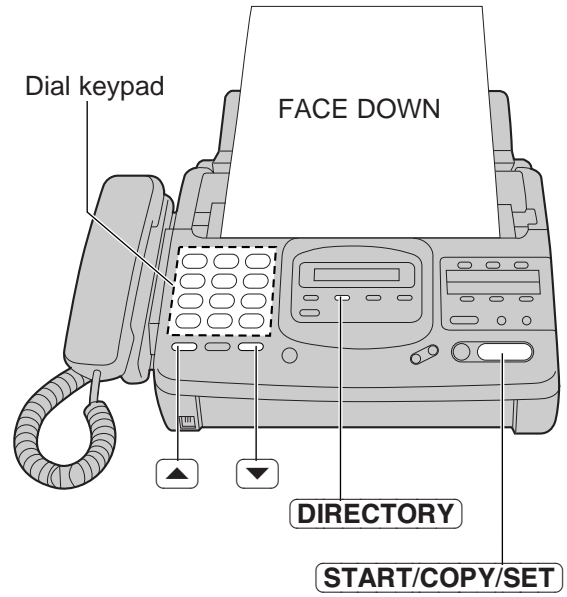

Dial key	Index	Dial key	Index
1	1	7	P, Q, R, S, 7
2	A, B, C, 2	8	T, U, V, 8
3	D, E, F, 3	9	W, X, Y, Z, 9
4	G, H, I, 4	0	0
5	J, K, L, 5	*	Other symbols
6	M, N, O, 6	#	(Used for speed dialing)

Voice contact

(talking to the caller during or after fax reception or transmission)

You can have a conversation with the same call after the fax message is completed. This will save the extra expense and time of making another call.

This feature works only when the other party's unit is equipped with a voice contact feature.

Initiating voice contact

- 1 Press **DIGITAL SP-PHONE** while transmitting or receiving documents.

VOICE STANDBY

- Your unit will call the other party with a distinctive ring.

- 2 When the other party answers, the unit will emit a distinctive ring.
Press **DIGITAL SP-PHONE** or lift the handset to start talking.

- If you initiate voice contact during transmission, you can talk after all the documents have been transmitted.
- If you initiate voice contact during reception, you can talk after the current page of the document is received.

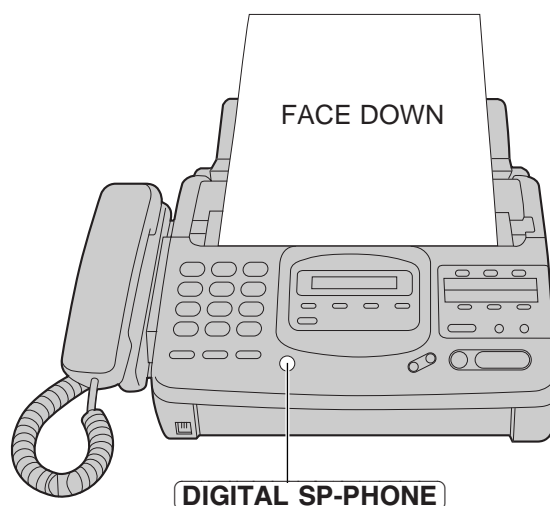

Receiving a request for voice contact

If the other party initiates voice contact, your unit will emit a distinctive ring after transmission or reception is completed.

When the distinctive ring is heard, press **DIGITAL SP-PHONE** or lift the handset, then start speaking.

Note:

- If you do not answer within 10 seconds of hearing the distinctive ring;
 - when your unit is in the ANS/FAX mode, your unit will play back a greeting message and record an incoming voice message.
 - when your unit is in the TEL/FAX, FAX or TEL mode, the line will be disconnected.

TONE, FLASH and REDIAL/PAUSE buttons

TONE button

The TONE (*) button is used for rotary pulse dial services and allows you to temporarily change from pulse to tone mode during a dialing operation. When you hang up, the unit will automatically return to pulse mode.

FLASH button

The FLASH button functions as the hookswitch on a regular phone. If you misdial or dial another phone number, press the FLASH button firmly.

The FLASH button also allows you to use special features of a host exchange (if connected) or local telephone company services such as call waiting. For further details, contact your local telephone company.

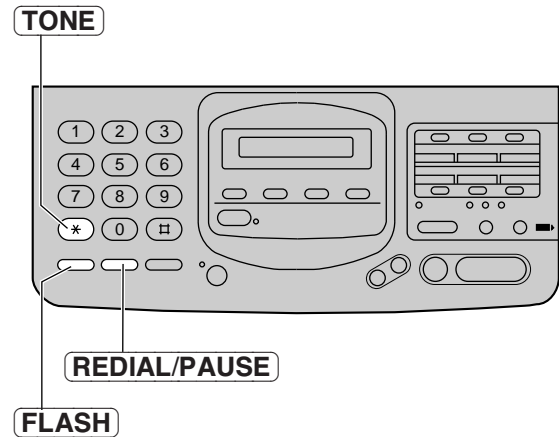

Note:

- TONE, FLASH and PAUSE can be stored into a phone number for automatic dialing.

Entering pauses

If the REDIAL/PAUSE button is pressed during dialing, a pause will be inserted.

Example-1: When your unit is connected to a host exchange, insert a pause to get an outside line.

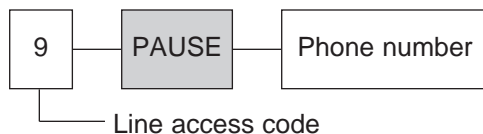

Example-2: If transmission errors occur when making an overseas transmission, add two pauses at the end of the phone number.

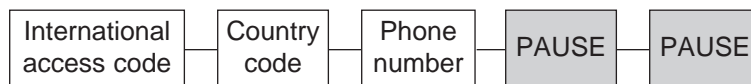

Redialing the last number dialed

If the REDIAL/PAUSE button is pressed immediately after a dial tone is obtained, the last number dialed will be redialed.

1. Lift the handset or press **DIGITAL SP-PHONE**.
2. Press **REDIAL/PAUSE**.

- If the line is busy when using the speakerphone, the unit will automatically redial the number up to 14 times.

Polling

(retrieving fax documents)

The polling feature allows you to receive a document from another compatible machine where you pay for the call as opposed to the document being sent to you, thereby saving the other party call charges.

Receive polling

To place a call and recover a document from another machine, follow the steps below. Make sure that no documents have been fed into your unit and that the other party's machine is ready for your call.

- 1 Press **MENU** until the following is displayed.

POLLING

- 2 Press **START/COPY/SET**.

NO. =

- 3 Enter the phone number by using one-touch dialing, speed dialing, full number dialing or the electronic telephone directory (see page 34).

- 4 Press **START/COPY/SET**.

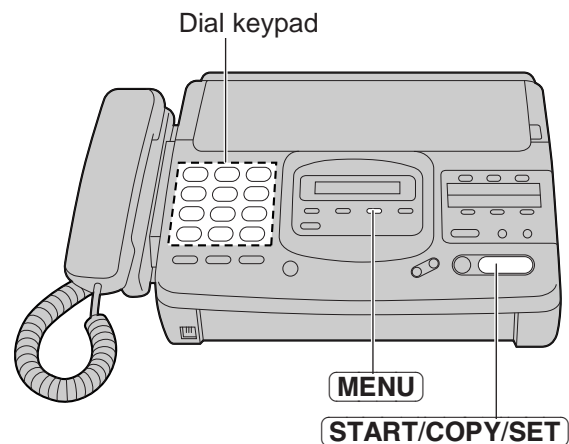

Transmit polling

A document stored in your unit can be recovered by another party's machine. To let other machines retrieve documents loaded on your unit, proceed as follows.

- 1 Insert the documents FACE DOWN.

- 2 Press **MENU** until the following is displayed.

POLLED

- 3 Press **START/COPY/SET**.

MODE=OFF [▲▼]

- 4 Press ▲ or ▼ to select "ON".

MODE=ON [▲▼]

- If this feature is not required, select "OFF".

- 5 Press **START/COPY/SET**.

POLLED ON

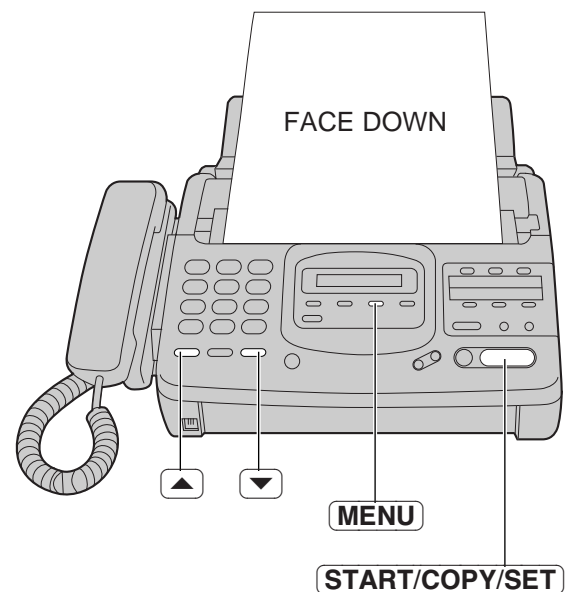

Note:

- When delayed transmission (page 38) is set to ON, transmit polling is not available.

Delayed transmission

(sending a fax at a later time)

Using a built-in clock, this unit can send documents automatically at a specific time. This allows you to take advantage of low-cost calling hours offered by your telephone company. The delayed transmission can be reserved to take place up to 24 hours.

1 Insert the documents FACE DOWN.

2 Press **MENU**.

SYSTEM SET UP

3 Press **#**, then press **2** **5**.

DELAYED XMT

4 Press **START/COPY/SET**.

MODE=OFF [▲▼]

5 Press **▲** or **▼** to select "ON".

MODE=ON [▲▼]

•If this feature is not required, select "OFF".

6 Press **START/COPY/SET**.

NO. =

7 Enter the phone number by using one-touch dialing, speed dialing, full number dialing or the electronic telephone directory.

8 Press **START/COPY/SET**.

TIME=12:00AM

9 Enter the transmission start time.

Example: 11:00PM

Press **1** **1** **0** **0**, then press **#** to select PM.

To select AM, press *****.

10 Press **START/COPY/SET**.

11 Press **MENU**.

•When the programmed time has come, the unit will automatically start transmission.

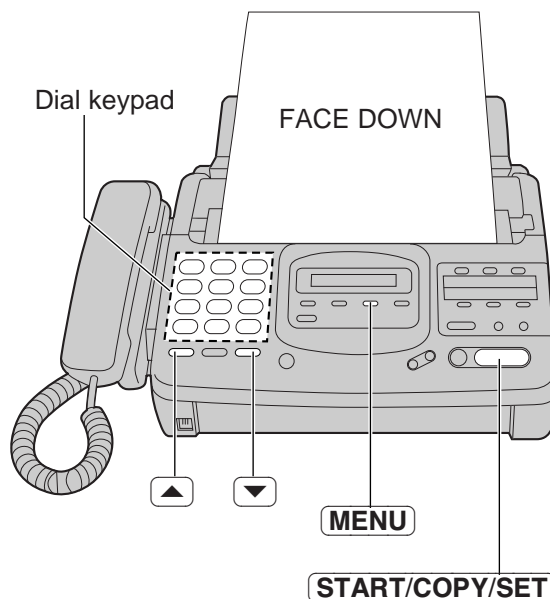

Note:

- You can receive, transmit and copy documents while delayed transmission is set.
- When transmit polling (see page 37) is ON, delayed transmission is not available.

Sending documents overseas

You may experience difficulty in transmitting documents overseas. This feature will make sending documents easier as the transmission speed is slowed down. Before starting the transmission procedure, follow the steps below.

- 1 Press **MENU**.
SYSTEM SET UP
- 2 Press **#**, then **2** **3**.
OVERSEAS MODE
- 3 Press **START/COPY/SET**.
MODE=OFF [▲▼]
- 4 Press ▲ or ▼ to select "ON".
MODE=ON [▲▼]

•If this feature is not required, select "OFF".

- 5 Press **START/COPY/SET**.
- 6 Press **MENU**.

Note:

- After transmission, this feature will be turned off automatically.

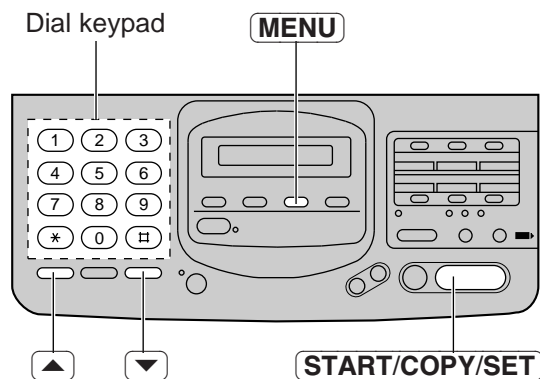

Remote fax receiving

(using an extension to receive a fax message)

If you have an extension phone on the same line, it is possible to receive a fax message. Using the extension phone, dial the remote fax activation code.

This saves you from going to the facsimile unit and pressing **START/COPY/SET**.

Important:

- To activate this feature, use a touch tone telephone as the extension phone and enter the remote fax activation code **FIRMLY**.
- The remote fax activation code is set to “**” as a pre-selected setting.

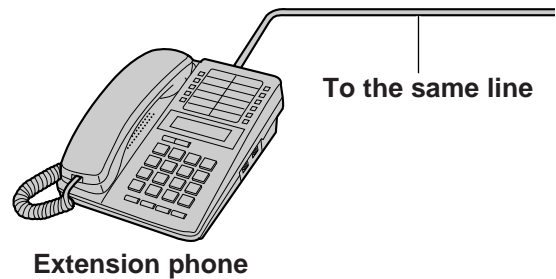

Receiving using an extension

- 1 When a call is received, lift the handset of the extension phone.
- 2 When:
 - document reception is required,
 - a slow beep is heard, or
 - no sound is heard,enter the remote fax activation code **FIRMLY**.
- 3 Hang up the handset.
 - The facsimile unit is activated for reception.



Changing the remote fax activation code

This code can be from 2 to 4 digits in length using numbers 0 through 9 and the character *.

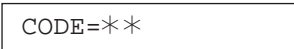
- 1 Press **MENU**.

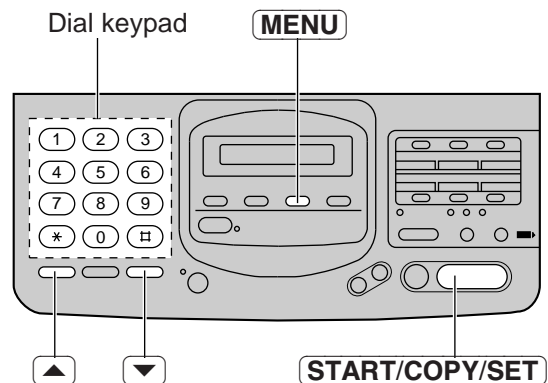
- 2 Press **#**, then **4** **1**.

- 3 Press **START/COPY/SET**.

- 4 Press **▲** or **▼** to select the desired setting.
 - If this feature is not required, select “OFF”.
- 5 Press **START/COPY/SET**.

- 6 Enter the new code number.
- 7 Press **START/COPY/SET**.
- 8 Press **MENU**.



Note:

- Some special telephone company services will require you to press a service access code. If you subscribe to such services, whole or part of the remote fax activation code must be different from the service access code.
- If the remote fax activation code is set to “0000”, the unit does not work properly.

Junk mail prohibitor





(preventing the reception of unwanted fax documents)

This feature prevents reception from facsimile machines whose phone numbers are not stored in automatic dialing.

Important:

- This feature does not work when:
 - the unit is set to the TEL mode,
 - manual reception is performed, or
 - the other party does not program their facsimile telephone number correctly.
- The junk mail prohibitor ID must be different from the first 2 digits of the remote operation ID (page 50) and the mailbox password (page 44).
 - e.g. if the remote operation ID is “321”, do not use “32” as a junk mail prohibitor ID.

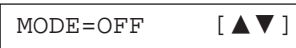
Setting the junk mail prohibitor and the ID

- 1 Press **MENU**.

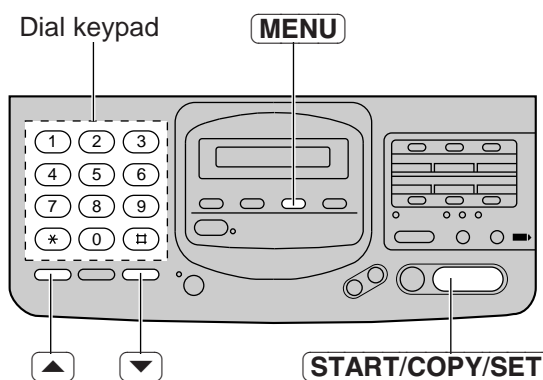
- 2 Press **#**, then **2** **4**.

- 3 Press **START/COPY/SET**.

- 4 Press **▲** or **▼** to select “ON”.

 - If this feature is not required, select “OFF”.
- 5 Press **START/COPY/SET**.

- 6 To change the junk mail prohibitor ID, enter the desired 2-digit number.
 - 0, #, and * cannot be used.
- 7 Press **START/COPY/SET**.
- 8 Press **MENU**.



Transmitting documents to your unit with the prohibitor ID—

Even if the junk mail prohibitor feature is activated, a designated caller will be able to transmit documents. Give your junk mail prohibitor ID to your designated callers, and advise them of the following steps. This operation is available in the AUTO RECEIVE mode (ANS/FAX only) or the MANUAL RECEIVE mode (TEL/FAX only).

1. Call your unit from a touch tone telephone.
2. Dial the prohibitor ID while the greeting message is playing or a different ring back tone is heard.
3. Listen for a fax tone, and start transmission.

Receiving with distinctive ring service

This feature can only be used by those who subscribe to a distinctive ring pattern service from their telephone company. For more information on the availability of this service, please contact your telephone company before setting this feature to ON.

The distinctive ring service gives you up to 3 phone numbers on a single telephone line, each having a different ringing pattern.

When you use one of the phone numbers as a facsimile number, program the ringing pattern assigned for fax into your unit. When the unit detects a call matching the selected distinctive ringing pattern, the unit will activate depending on the receive mode setting.

Setting the distinctive ringing pattern

Program the ring pattern assigned for fax. Ringing patterns that can be programmed are;

- A: Standard ring (One long ring)
- B: Double ring (Two short rings)
- C: Triple ring (Short-long-short rings)
- D: Other triple ring (Short-short-long rings)
- OFF: Turns off the ring pattern detection feature (pre-selected setting)

1 Press **MENU**.

SYSTEM SET UP

2 Press **#**, then **3** **1**.

RING DETECTION

3 Press **START/COPY/SET**.

MODE=OFF [▲▼]

4 Press **▲** or **▼** to select the desired mode.

5 Press **START/COPY/SET**.

6 Press **MENU**.

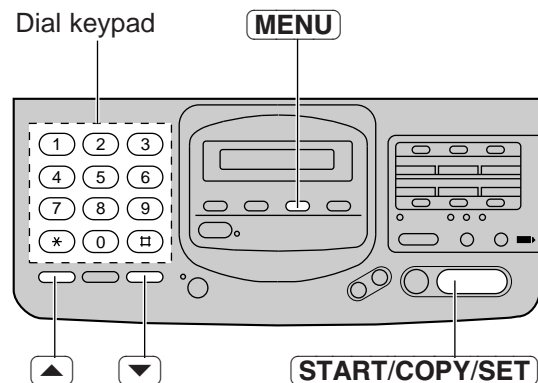

How the unit will answer in each receive mode

- **ANS/FAX mode:** When a distinctive ringing pattern that matches your selection is detected, the unit will automatically answer the line and activate the fax function to receive documents. If other ringing patterns are received, the unit will activate the fax function or the answering system depend on the call.
- **TEL/FAX mode:** When a distinctive ringing pattern that matches your selection is detected, the unit will automatically answer the line and activate the fax function to receive documents. If other ringing patterns are received, the unit will ring until you pick up.
- **TEL mode:** In this mode, you have to answer all calls manually.
- **FAX mode:** In this mode, the unit will answer all calls and activate the fax function.

Note:

- The unit automatically answers a distinctive ring call after the second ring. To change the number of rings, change the FAX mode ring count (page 24) after setting the ringing pattern.

Signaling your pager that you have received a fax document

This feature allows your unit to call your pager when your unit receives a fax message.

1 Press **MENU**.

SYSTEM SET UP

2 Press **#**, then **7** **0**.

FAX PAGER

3 Press **START/COPY/SET**.

MODE=OFF [▲▼]

4 Press **▲** or **▼** to select "ON".

MODE=ON [▲▼]

•If this feature is not required, select "OFF".

5 Press **START/COPY/SET**.

NO. =

6 Enter your pager phone number.
If necessary, press **REDIAL/PAUSE** twice.
Contact your pager company regarding the proper pause time.

If your pager has the ability to display phone numbers, enter the number that you wish to appear on the display.
Press **#** if required by your pager company.

•You may enter a total of 46 digits and/or pauses.

7 Press **START/COPY/SET**.

8 Press **MENU**.

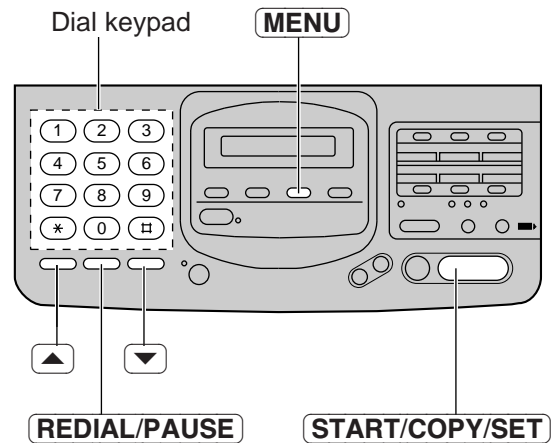

Voice mailbox

(how callers can leave you private messages)

This unit has three mailbox memories. Your caller can leave a message in a specific mailbox. Only the person who knows the password can retrieve a message from a mailbox.

This feature is useful when you use this unit with other people and when a caller would like to leave a message directly to a specific person.

To use a mailbox:

1. Program the mailbox password (see below).
2. Inform the mailbox number to callers.
3. Set the unit to the ANS/FAX mode (see pages 14 and 15).

Note:

- The unit has a pre-recorded greeting message in each memory.

Pre-recorded greeting message (e.g. Mailbox 1):

*This is mailbox 1.
Please leave your name and message after the beep.*

You can record your own greeting message (see page 54).

Programming the mailbox password

Program your own password for your mailbox to prevent other users from retrieving messages. Choose any 3-digit number except a number using digits 0 or 7.

The mailbox password must be different from the first 2 digits of the junk mail prohibitor ID (page 41) and the remote operation ID (page 50).

- 1** Press **MENU**.

SYSTEM SET UP

- 2** For mailbox 1, press **#**, then **5** **1**.

BOX1 PASSWORD

- For mailbox 2, press **#**, then **5** **2**.

BOX2 PASSWORD

- For mailbox 3, press **#**, then **5** **3**.

BOX3 PASSWORD

- 3** Press **START/COPY/SET**.

NO. =

- 4** Enter the new password.

- 5** Press **START/COPY/SET**.

- To program other passwords, repeat from step 2.

- 6** Press **MENU**.

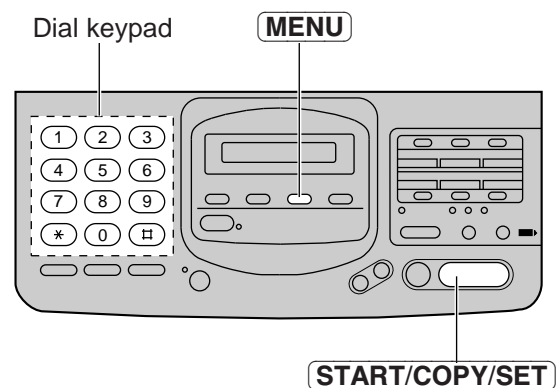

How incoming messages are recorded in a mailbox

- 1 Call your unit from a touch tone telephone.
 - The ANS/FAX greeting message will be played.

Pre-recorded greeting message:

*Hello! We are unable to answer right now.
To send a fax, please start transmission.
To leave a voice message, please speak after the beep.
Thank you.*

- 2 Press **[*]** and the desired mailbox number (**[1]**, **[2]** or **[3]**).
 - A mailbox greeting message will be played.

*This is mailbox (1-3).
Please leave your name and message after the beep.*

- 3 After the beep, leave a message.

Recording a memo message and a telephone conversation

You can record a memo message and a telephone conversation into a mailbox. Press **[MAIL BOX]** until the desired mailbox number is displayed and follow the instructions on pages 30 and 31.

Listening to messages in a mailbox

When there is a new message in a mailbox,
—the mailbox number indicator will flash, and
—a slow beep will sound if mailbox alert is set to ON (see page 46).

- 1 Press **[MAIL BOX]** until the desired mailbox number is displayed.

Example: Mailbox 2

BOX2	02
------	----

- 2 ■ If you leave the mailbox password as "555" (pre-selected setting);

Press **[NEW MSGS. PLAYBACK]** lightly.

or

- If you program your own password;

Press **[NEW MSGS. PLAYBACK]** lightly, then enter your password.

PASSWORD=

- The unit will play back the new recorded messages.

- 3 To exit the mailbox, press **[STOP]**.

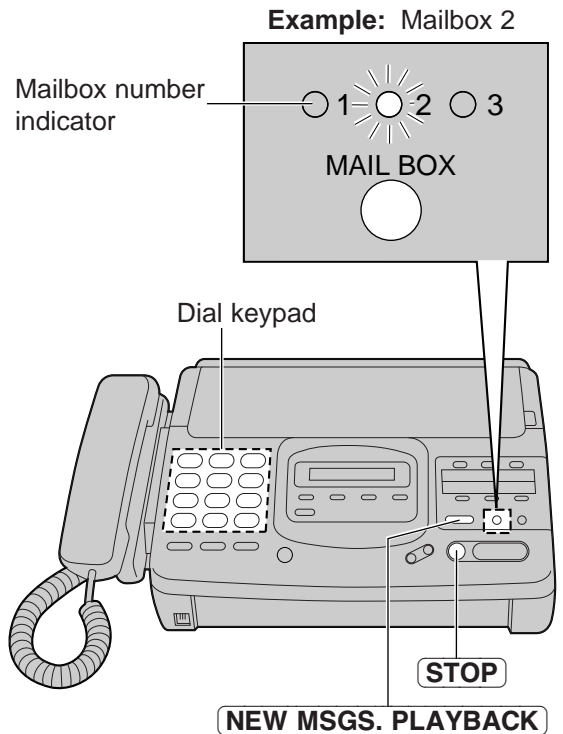

Note:

- **[REPEAT]**, **[SKIP]**, **[STOP]**, **[QUICK]** and **[SLOW]** can be used during playback (see page 30).
- To listen to all of the recorded messages, press **[NEW MSGS. PLAY BACK]** firmly in step 2 until a beep is heard.

Erasing recorded messages in a mailbox

Erasing a specific message in a mailbox

Press **ERASE** while the message you want to erase is playing.

Erasing all messages in a mailbox

1 Press **MAIL BOX** until the desired mailbox number is displayed.

Example: Mailbox 1

BOX1 02

2 Press **ERASE**.

BOX1 ERASE OK?

3 Press **START/COPY/SET**.

ERASE COMPLETED

4 To exit the mailbox, press **STOP**.

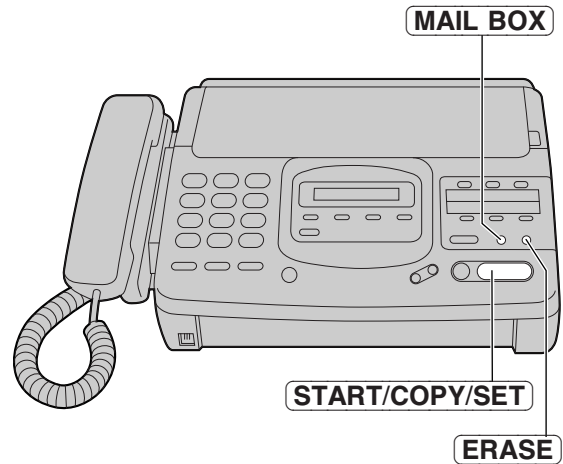

Setting the mailbox alert

This feature allows your unit to alert you with a slow beep that a caller's message is recorded in a mailbox.

1 Press **MENU**.

SYSTEM SET UP

2 Press **#**, then **5** **0**.

MAIL BOX ALERT

3 Press **START/COPY/SET**.

MODE=OFF [▲▼]

4 Press **▲** or **▼** to select "ON".

MODE=ON [▲▼]

•If this feature is not required, select "OFF".

5 Press **START/COPY/SET**.

6 Press **MENU**.

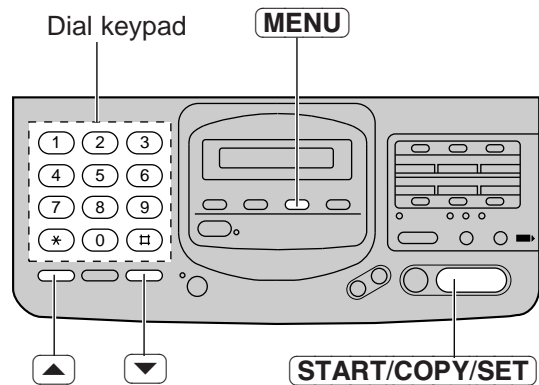

Transferring incoming calls

Each time an incoming message is recorded in a specific memory (common, mailbox1, mailbox2, or mailbox3), this feature allows your unit to dial automatically the number to which the message is to be transferred (**Message Transfer**) or your pager phone number (**Pager call**) and inform you that the message has been recorded.

—If you choose **Message transfer**, you can retrieve the message on the same call by the remote operation.

—If you choose **Pager call**, call your unit from a touch tone telephone to retrieve the message by the remote operation.

For details on the remote operation, see page 49.

This feature is available in the ANS/FAX mode.

When an incoming call is received, the unit will work as follows.

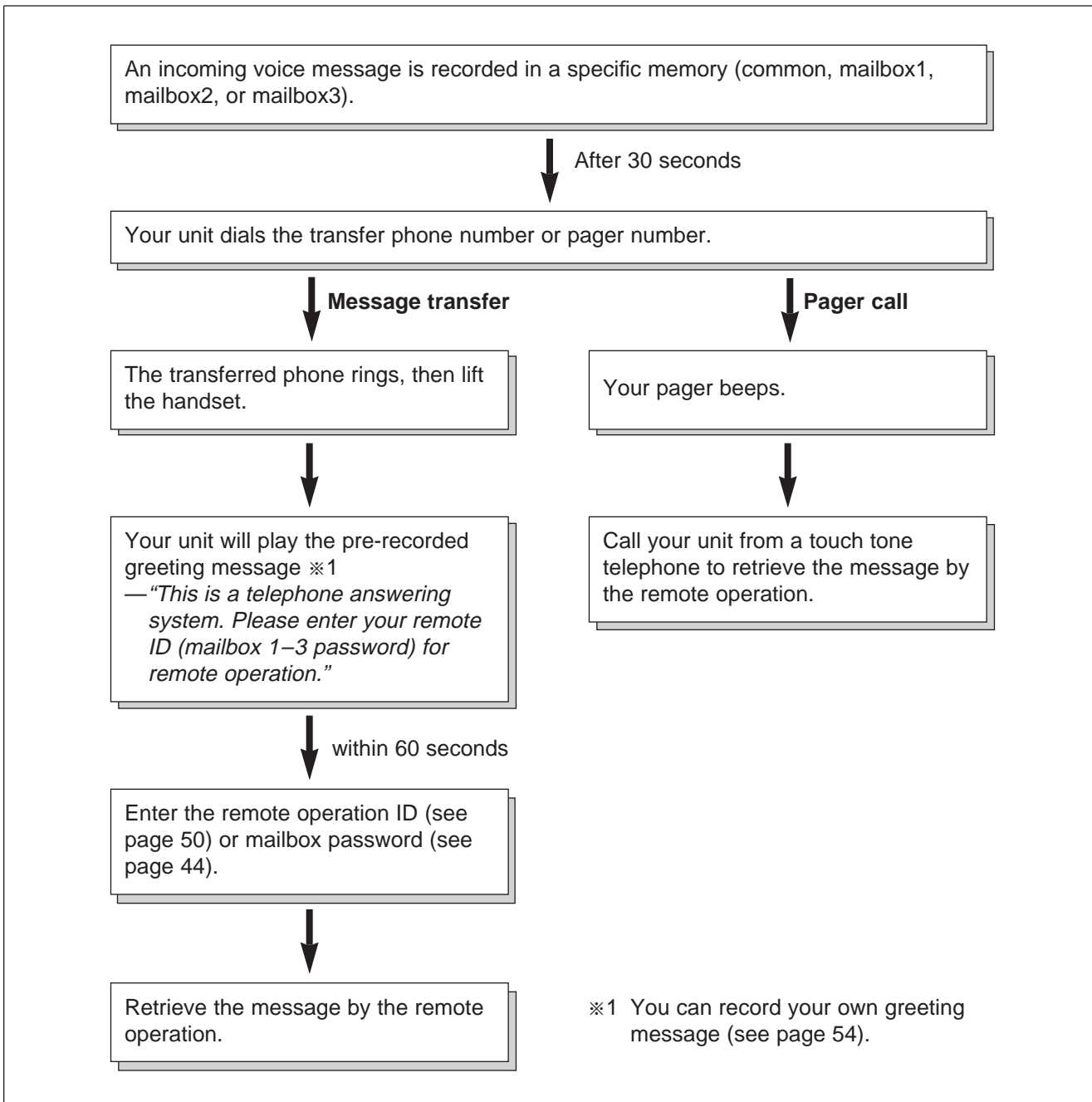

Setting the message transfer/pager call

1 Press **MENU**.

SYSTEM SET UP

2 For common message transfer,
press **#**, then **6 0**.

COMMON MSG TRNSF

For mailbox 1 message transfer,
press **#**, then **6 1**.

BOX1 MSG TRNSF

For mailbox 2 message transfer,
press **#**, then **6 2**.

BOX2 MSG TRNSF

For mailbox 3 message transfer,
press **#**, then **6 3**.

BOX3 MSG TRNSF

3 Press **START/COPY/SET**.

MODE=OFF [▲▼]

4 Press **▲** or **▼** to select the desired setting.
MESSAGE: transfers incoming messages.
PAGER: calls your pager.
OFF: turns off this feature.

5 Press **START/COPY/SET**.

NO. =

6 a: If you selected “MESSAGE” in step 4:
Enter the number where the message is to be transferred.

b: If you selected “PAGER” in step 4:
Enter your pager phone number.

If necessary, press **REDIAL/PAUSE** twice.
Contact your pager company regarding the proper pause time.

If your pager has the ability to display phone numbers, enter the number that you wish to appear on the display.

Press **#** if required by your pager company.

•You may enter a total of 46 digits and/or pauses.

7 Press **START/COPY/SET**.

8 Press **MENU**.

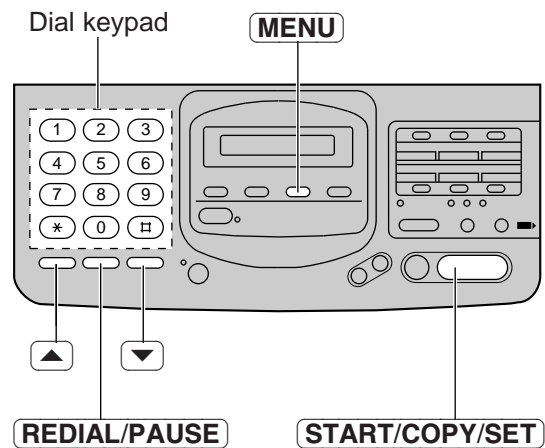

Note:

•This feature can be turned on/off remotely from a touch tone phone (see page 53).

Operating the answering device from a remote phone

The following operations are available from a remote location with a touch tone telephone. Set the unit to the ANS/FAX mode in the AUTO RECEIVE mode before going out (see pages 14 and 15).

Dial key	Remote command	Page	Dial key	Remote command	Page
1	Repeats a message	52	*4	Erases a specific message	52
2	Skips a message	52	*5	Erases all messages	52
4	New message playback	51	8 1	Turns on message transfer /pager call for incoming messages	53
5	All message playback	51			
6	Room monitor	52	8 2	Turns off message transfer /pager call for incoming messages	53
7	Re-records a greeting message	53			
9	Stops re-recording of a greeting message	53	0	Skips the greeting message	53

Remote operation card

- You may cut out this remote operation card to use.

Mailbox Remote Operation

Notice of Remote Operation

- **Recording a message in a mailbox:**

 1. Call your unit.
 2. Press * and the mailbox no. (1, 2 or 3).
 3. Leave a message.
- **Retrieving messages from a mailbox:**

 1. Call your unit.
 2. Press * and the mailbox no. (1, 2 or 3).
 3. Enter the mailbox password □□□.
 4. Press the remote command key (refer to the reverse side).

Fold here

- The remote operation is available only from a touch tone phone when the unit is in the ANS/FAX mode.
- When the unit is in the TEL mode, call your unit and wait for 15 rings. The answering system will temporarily answer the line. Enter the remote operation ID during the greeting message. The unit will switch to the ANS/FAX mode.
- When you press any key, press firmly.
- To send a document, press **. When a fax tone is heard, start transmission.

Programming the remote operation ID

The remote operation ID is used to access the answering device common memory. Choose any 3-digit number except a number using digits 0 or 7.

Make sure that the first 2-digits of the remote operation ID are different from the junk mail prohibitor ID (page 41) and the mailbox password (page 44).

1 Press **MENU**.

SYSTEM SET UP

2 Press **#**, then **1 1**.

REMOTE ANS ID

3 Press **START/COPY/SET**.

ID=111

4 Enter the desired number.

5 Press **START/COPY/SET**.

6 Press **MENU**.

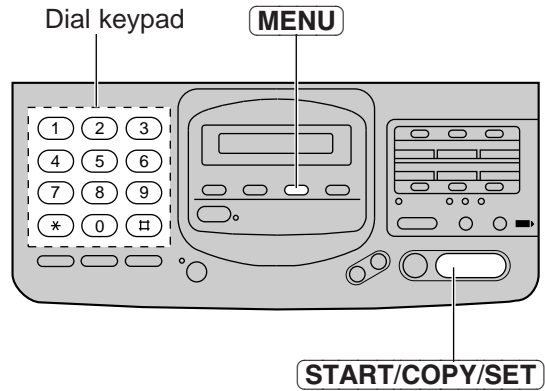

Answering Device Remote Operation

1. Call your unit.
2. Enter the remote operation ID during the greeting message.
3. Press the remote command key (refer to the right) within 4 seconds.
or
Wait for 4 seconds. All the recorded messages will be played back.

Key	Remote Command
<input type="button" value="0"/>	Skips the greeting message
<input type="button" value="1"/>	Repeats a message
<input type="button" value="2"/>	Skips a message
<input type="button" value="4"/>	New message playback
<input type="button" value="5"/>	All message playback
<input type="button" value="6"/>	Room monitor
<input type="button" value="7"/>	Re-records a greeting message
<input type="button" value="9"/>	Stops re-recording of a greeting message
<input type="button" value="✕4"/>	Erases a specific message
<input type="button" value="✕5"/>	Erases all messages
<input type="button" value="81"/>	Message transfer/Pager call ON
<input type="button" value="82"/>	Message transfer/Pager call OFF

Listening to messages in common memory

- 1 Call your unit.
- 2 Enter the remote operation ID during the ANS/FAX greeting playback.
—The voice guide will tell you the number of new recorded messages.
- 3 Press **4** to listen to the new recorded messages.
OR
Press **5** or wait for 4 seconds to listen to all of the recorded messages.

Example of the voice guide:

*3 new messages in common memory.
No new messages in mailbox.*

—The voice guide will tell you how to operate the unit during playback.

*Playback 3 new messages.
Press **1** to repeat message.
Press **2** to skip message.
Press ***4** to erase a specific message.*

Listening to messages in a mailbox

- 1 Call your unit.
- 2 Press ***** and the desired mailbox number (**1**, **2** or **3**) during the ANS/FAX greeting playback.
- 3 Enter the mailbox password during the mailbox greeting message.
—The voice guide will tell you the number of new recorded messages.
- 4 Press **4** to listen to the new recorded messages.
OR
Press **5** or wait for 4 seconds to listen to all of the recorded messages.

Example of mailbox greeting message:

*This is mailbox (1–3).
Please leave your name and message
after the beep.*

Example of the voice guide:

3 new messages in mailbox (1–3).

—The voice guide will tell you how to operate the unit during playback.

*Playback 3 new messages.
Press **1** to repeat message.
Press **2** to skip message.
Press ***4** to erase a specific message.*

To listen to messages in another memory after playback

1. Press ***** and **0** (for common memory), then enter the remote operation ID.
or
Press ***** and the desired mailbox number (**1**, **2** or **3**), then enter the mailbox password during the mailbox greeting message.
2. Press **4** or **5** to play back messages.

During playback

■ Repeating a message:

Press **1** to play the current message.

—If you press **1** within 5 seconds of playback, the previous message will be played.

■ Skipping a message:

Press **2** to play back the next message.

Note:

- If you hear the voice guide after playing back the messages, memory is full. Erase some or all of the messages.

Example of the voice guide:

Not enough recording time. Please erase unnecessary messages.

Erasing incoming messages from memory

■ Erasing a specific message from memory

Press *** 4** when the message you want to erase is played.

—A long beep and the voice guide will be heard.
Then the unit will continue with the next message.

Example of the voice guide:

The message has been erased.

■ Erasing all messages from a specific memory

You can erase all of the recorded messages from common and each mailbox memory.
To erase all of the messages in a mailbox, you must first select a mailbox.

Press *** 5** when you want to erase the messages in a specific memory.

—A long beep and the voice guide will be heard.

Example of the voice guide:

All messages have been erased.

Other remote operations

■ Monitoring the room sound

You can monitor the sound in the room where the unit is installed.

Press **6** during the remote operation.

—You can monitor the room sound for about 30 seconds.

Note:

- After 30 seconds are up, a beep sounds. To continue monitoring, press **6** again within 10 seconds.

■ Recording a marker message

After playing back the recorded messages, you can leave an additional message.

1. Wait for the voice guide indicating the end of the remote operation.
2. Wait about 10 seconds until the voice guide is played.
3. Leave a message after the beep.

Example of the voice guide:

All messages have been played.

Please leave your name and message after the beep.

■ Re-recording a greeting message

You can change the contents of the greeting messages for the ANS/FAX mode and mailbox memories. To re-record a mailbox greeting message, you must first select a mailbox.

1. Press **[7]** to start recording during the remote operation.
 - A long beep will sound.
2. Speak up to 16 seconds.
 - If you pause for over 2 seconds, 6 beeps will sound and the recording will stop. Repeat from step 1 within 10 seconds.
3. When finished, press **[9]**.
 - The new greeting message will be played.

■ Turning message transfer/pager call on or off

You can remotely turn on or off message transfer/pager call for incoming messages. You must program a transfer phone number or a pager number in advance (see page 48).

Press **[8][1]** to turn ON message transfer/pager call during the remote operation.

Example of the voice guide:

*Message transfer is set.
Transfer phone number is 123456789.
or
Pager call is set.
Pager number is 098765432.*

Press **[8][2]** to turn OFF message transfer/pager call.

*Message transfer is off.
or
Pager call is off.*

—If a transfer phone number or a pager number is not programmed, the voice guide will be played. You cannot turn this feature on.

*Transfer phone number is not set.
or
Pager number is not set.*

■ Skipping the greeting message

You can skip the greeting message.

Press **[0]** during the greeting message playback.
—The unit will skip the rest of the greeting message.

Recording your own greeting messages

You can record 6 types of greeting messages. The recording time is limited to 16 seconds for each message. Record a greeting message within 12 seconds for optimum performance.

<p>ANS/FAX greeting message Mailbox 1 greeting message Mailbox 2 greeting message Mailbox 3 greeting message Message transfer greeting message</p>	<p>For the pre-recorded greeting message, see pages 22, 44 and 47. You can record your own greeting messages. Suggested message for the ANS/FAX greeting message "This is (your name, business and/or telephone number). We are unable to answer right now. To send a fax, start transmission. To leave a message, speak after a long beep. Thank you."</p>
<p>TEL/FAX greeting message</p>	<p>No pre-recorded greeting message. Record your own greeting message. Suggested message "This is (your name, business and/or telephone number). Please wait for someone to answer your call. To send a fax, start transmission."</p>

Note:

- As for the ANS/FAX greeting message, you can choose 16 seconds or 60 seconds of recording time (see page 57).

- 1 Open the station key panel.
- 2 Press **SELECT** until the following is displayed.

- For the ANS/FAX greeting:

ANS-GREETING

- For the TEL/FAX greeting:

TEL-GREETING

- For mailbox 1–3 greeting:

Example: Mailbox 2

BOX2-GREETING

- For message transfer greeting:

TRNS-GREETING

- 3 Press **REC**.
 - A long beep will sound.

- 4 Speak clearly 20 cm (8 inches) away from the microphone.
 - The display will show the elapsed recording time.
 - Example:** The ANS/FAX greeting

ANS REC. 02s

- 5 When finished, press **STOP**.
 - The unit will repeat your message. Adjust the volume using **VOLUME**.

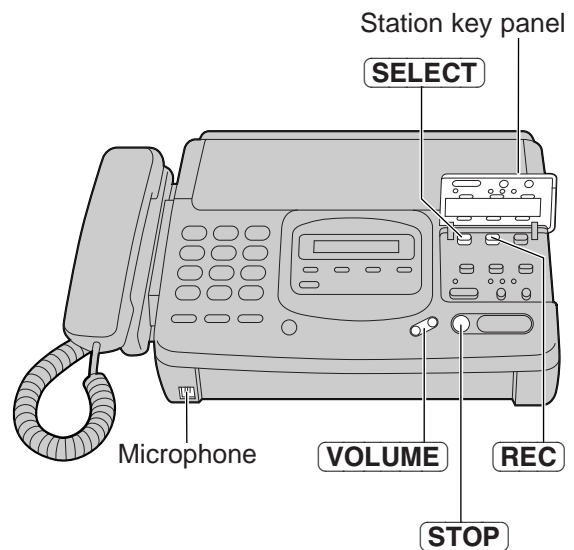

Note:

- If you make a mistake while recording, repeat from step 2.
- If you don't record a TEL/FAX greeting message, the display shows "NO TEL GREETING".

Checking greeting messages

- 1 Open the station key panel.
- 2 Press **SELECT** until the desired greeting is displayed.

Example: Mailbox 3 greeting

BOX3-GREETING

- 3 Press **CHECK**.
 - After the beep, the unit will play back the message.
 - Adjust the volume using **VOLUME**.

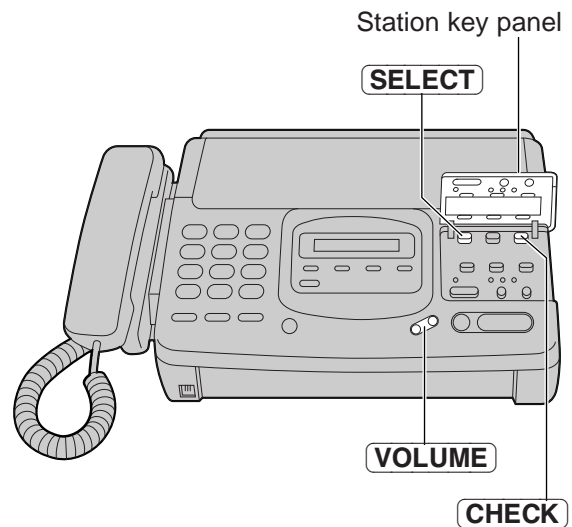

Erasing your own recorded greeting messages

- 1 Open the station key panel.
- 2 Press **SELECT** until the desired greeting is displayed.

Example: Message transfer greeting

TRNS-GREETING

- 3 Press **ERASE**.

ERASE OK?

- 4 Press **START/COPY/SET**.

GREETING ERASED

- 5 Press **STOP**.

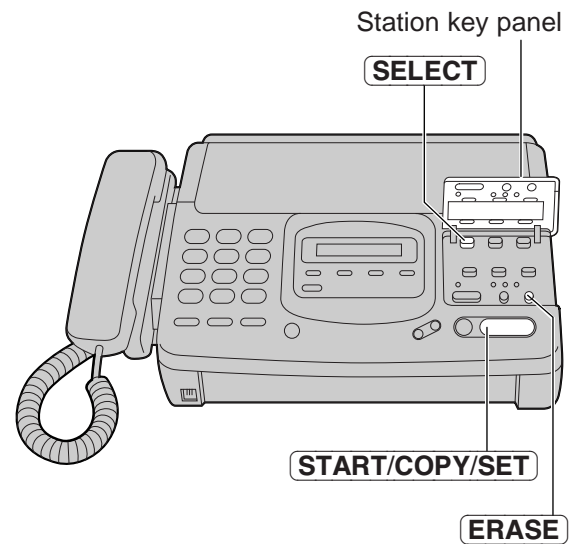

Note:

- If you erase your own recorded greeting messages, the pre-recorded greeting messages will be played.

Changing the caller's recording time

You can choose from two lengths of recording times for incoming messages.

VOX (unlimited): The unit records an incoming message as long as the caller speaks (pre-selected setting).

1 MIN (1 minute): The unit will record each incoming message up to 1 minute.

- 1 Press **MENU**.
SYSTEM SET UP
- 2 Press **#**, then **1** **0**.
RECORDING TIME
- 3 Press **START/COPY/SET**.
MODE=VOX [▲▼]
- 4 Press ▲ or ▼ to select the desired setting.
- 5 Press **START/COPY/SET**.
- 6 Press **MENU**.

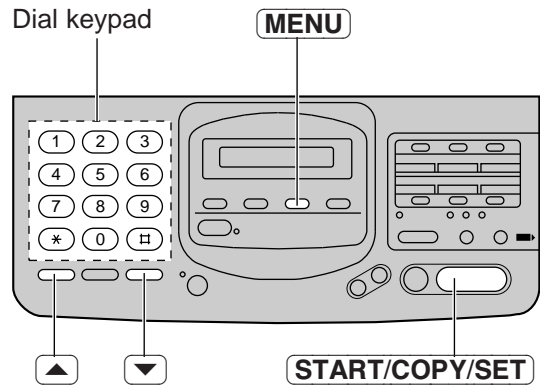

Setting the message alert

When this feature is on, the unit will let you know with a slow beep that a caller's message is recorded in the common memory.

- 1 Press **MENU**.
SYSTEM SET UP
- 2 Press **#**, then **4** **2**.
MESSAGE ALERT
- 3 Press **START/COPY/SET**.
MODE=OFF [▲▼]
- 4 Press ▲ or ▼ to select "ON".
MODE=ON [▲▼]

•If this feature is not required, select "OFF".

- 5 Press **START/COPY/SET**.
- 6 Press **MENU**.

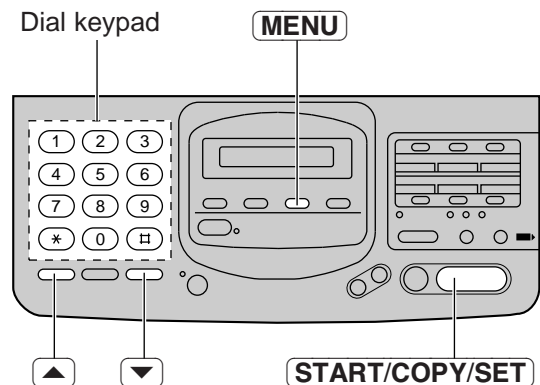

Setting the recording time alert

With this feature, when the remaining time to record incoming messages becomes less than 60 seconds, the unit will alert the user with a slow beep.

- 1 Press **MENU**.
SYSTEM SET UP
- 2 Press **#**, then **4** **3**.
REC. TIME ALERT
- 3 Press **START/COPY/SET**.
MODE=OFF [▲▼]
- 4 Press ▲ or ▼ to select "ON".
MODE=ON [▲▼]

•If this feature is not required, select "OFF".

- 5 Press **START/COPY/SET**.

- 6 Press **MENU**.

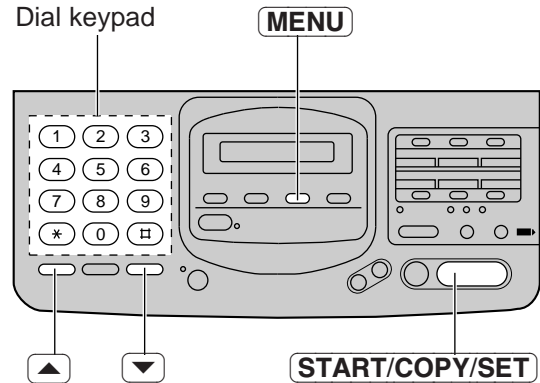

Changing the recording time for the ANS/FAX greeting message

You can choose 16 seconds or 60 seconds of recording time.

- 1 Press **MENU**.
SYSTEM SET UP
- 2 Press **#**, then **5** **4**.
GREETING TIME
- 3 Press **START/COPY/SET**.
MODE=16s
- 4 Press ▲ or ▼ to select the desired setting.

- 5 Press **START/COPY/SET**.

- 6 Press **MENU**.

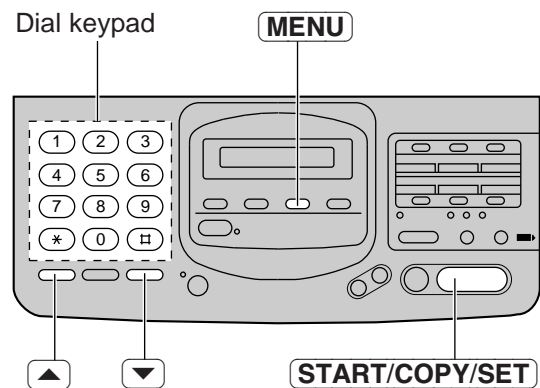

Note:

- If you change the greeting message time to 60 seconds, we recommend that you inform the caller in the ANS/FAX greeting message to press ** before starting fax transmission.
- If you change the greeting message time to 16 seconds from 60 seconds, your ANS/FAX greeting message is deleted. Re-record a greeting message (see page 54).

Changing the logo print position

The logo, telephone number, date, time and page number will be printed on the transmitted document from your unit in the following manner.

OUT: Outside of the transmitted document's paper size (pre-selected setting).

IN: Inside of the transmitted document's paper size.

1 Press **MENU**.

SYSTEM SET UP

2 Press **#**, then **2** **1**.

LOGO POSITION

3 Press **START/COPY/SET**.

MODE=OUT [▲▼]

4 Press ▲ or ▼ to select the desired setting.

5 Press **START/COPY/SET**.

6 Press **MENU**.

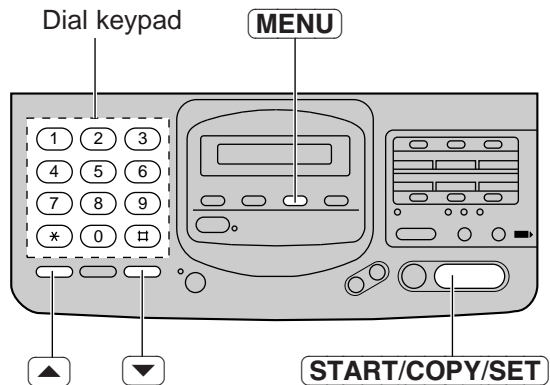

Changing the display contrast

Use this feature to adjust the brightness of the display.

NORMAL: (Pre-selected setting)

DARKER: Used when the display contrast is too light.

1 Press **MENU**.

SYSTEM SET UP

2 Press **#**, then **3** **9**.

LCD CONTRAST

3 Press **START/COPY/SET**.

MODE=NORMAL [▲▼]

4 Press ▲ or ▼ to select the desired setting.

5 Press **START/COPY/SET**.

6 Press **MENU**.

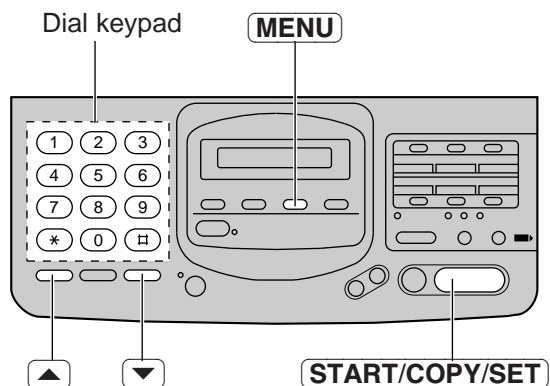

Setting the friendly reception

The friendly reception feature allows you to receive fax documents automatically without pressing **START/COPY/SET**. See page 21 for further details.

If you set this feature to OFF, you will have to press **START/COPY/SET** to receive fax documents each time you answer a call.

- 1 Press **MENU**.
SYSTEM SET UP
- 2 Press **#**, then **4** **6**.
FRIENDLY RCV
- 3 Press **START/COPY/SET**.
MODE=ON [▲▼]
- 4 Press ▲ or ▼ to select the desired setting.
- 5 Press **START/COPY/SET**.
- 6 Press **MENU**.

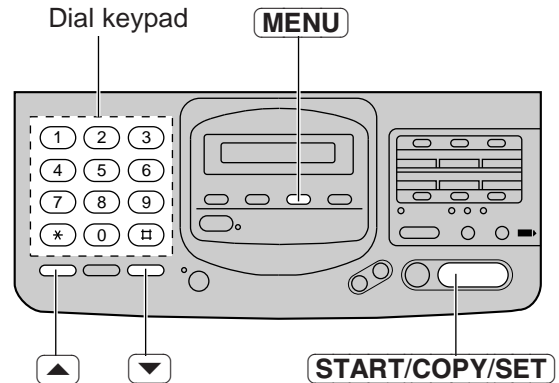

Note:

- If you set the fax voice guidance feature to OFF (see below), you cannot hear the message of the friendly reception.

Setting the fax voice guidance

With this feature, the voice guidance about transmission, reception and the friendly reception will be heard (see pages 19 and 21). If you do not want to hear this guidance, set this feature to OFF.

- 1 Press **MENU**.
SYSTEM SET UP
- 2 Press **#**, then **4** **7**.
FAX GUIDANCE
- 3 Press **START/COPY/SET**.
MODE=ON [▲▼]
- 4 Press ▲ or ▼ to select the desired setting.
- 5 Press **START/COPY/SET**.
- 6 Press **MENU**.

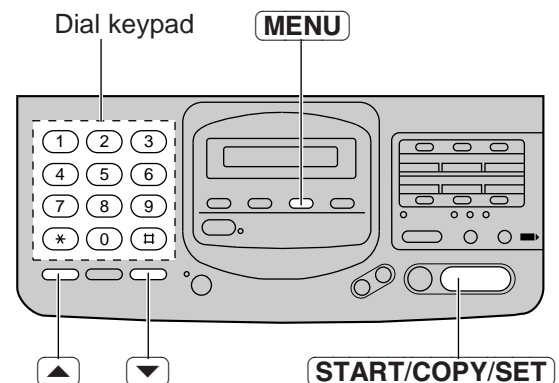

Setting the handset switch

This unit can work without the handset and handset cradle. When you don't use the handset and cradle, set this feature to NO HANDSET.

USE HANDSET: Choose when you use the handset and handset cradle (pre-selected setting).

NO HANDSET: Choose when you don't use the handset and handset cradle.

- 1 Press **MENU**.
SYSTEM SET UP
- 2 Press **#**, then **8** **9**.
HANDSET SWITCH
- 3 Press **START/COPY/SET**.
USE HANDSET [▲▼]
- 4 Press ▲ or ▼ to select the desired setting.
- 5 Press **START/COPY/SET**.
- 6 Press **MENU**.

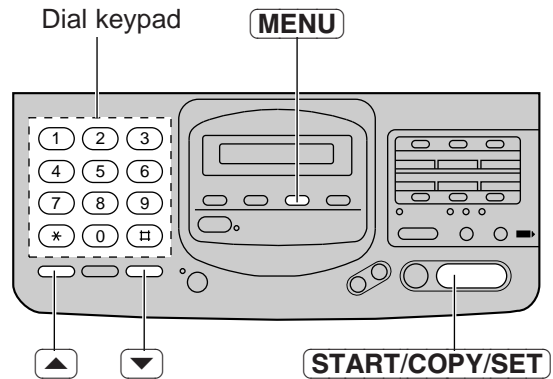

Note:

- After setting NO HANDSET, disconnect and connect the power cord again.

Resetting the advanced features

Use this feature to return the advanced features (see page 61) to their pre-selected settings.

- 1 Press **MENU**.
SYSTEM SET UP
- 2 Press **#**, then **8** **0**.
SET DEFAULT
- 3 Press **START/COPY/SET**.
RESET=NO [▲▼]
- 4 Press ▲ or ▼ to select "YES".
RESET=YES [▲▼]
- 5 Press **START/COPY/SET**.
RESET OK?
- If this feature is not required, press **STOP**.
- 6 Press **START/COPY/SET** again for confirmation.
RESET COMPLETED
- 7 Press **MENU**.

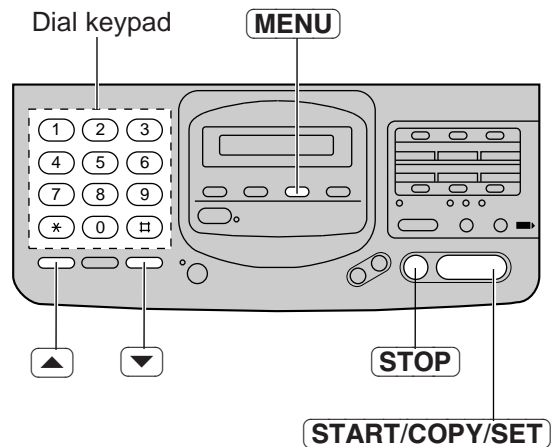

Summary of user programmable features

Basic features

Code	Feature	Selection	Initial setting	Page
#01	SET DATE & TIME	mm/dd/yy hh:mm		11
#02	YOUR LOGO			12
#03	YOUR TELEPHONE NUMBER			12
#04	PRINT TRANSMISSION REPORT	ERROR, ON, OFF	ERROR	63
#05	AUTO RECEIVE MODE	ANS/FAX, FAX	ANS/FAX	15
#06	ANS/FAX RING COUNT	1-4 rings, TOLL SAVER, RINGER OFF	1 ring	23
#07	FAX RING COUNT	1-4 rings	1 ring	24
#08	MANUAL RECEIVE MODE	TEL, TEL/FAX	TEL	15
#09	TEL/FAX DELAYED RING	1-4 rings	1 ring	26
#10	RECORDING TIME	VOX (unlimited), 1 minute	VOX	56
#11	REMOTE ANS ID		ID=111	50

Advanced features

Code	Feature	Selection	Initial setting	Page
#21	LOGO POSITION	OUT, IN	OUT	58
#22	JOURNAL AUTO PRINT	ON, OFF	ON	63
#23	OVERSEAS MODE	ON, OFF	OFF	39
#24	JUNK MAIL PROHIBITOR	ON, OFF	OFF/ID=22	41
#25	DELAYED TRANSMISSION	ON, OFF	OFF	38
#30	SILENT FAX RECOGNITION RING	3-6 rings	3 rings	27
#31	RING DETECTION	OFF, A, B, C, D	OFF	42
#39	LCD CONTRAST	NORMAL, DARKER	NORMAL	58
#41	REMOTE FAX ACTIVATION CODE	ON, OFF	ON/ID=**	40
#42	MESSAGE ALERT	ON, OFF	OFF	56
#43	RECORDING TIME ALERT	ON, OFF	OFF	57
#46	FRIENDLY RECEPTION	ON, OFF	ON	59
#47	FAX VOICE GUIDANCE	ON, OFF	ON	59
#50	MAIL BOX ALERT	ON, OFF	OFF	46
#51	BOX1 PASSWORD		555	44
#52	BOX2 PASSWORD		555	44
#53	BOX3 PASSWORD		555	44
#54	COMMON GREETING MESSAGE RECORDING TIME	16s, 60s	16s	57
#60	COMMON MESSAGE TRANSFER	OFF, MESSAGE, PAGER	OFF	48
#61	MAIL BOX1 MESSAGE TRANSFER	OFF, MESSAGE, PAGER	OFF	48
#62	MAIL BOX2 MESSAGE TRANSFER	OFF, MESSAGE, PAGER	OFF	48
#63	MAIL BOX3 MESSAGE TRANSFER	OFF, MESSAGE, PAGER	OFF	48
#70	FAX PAGER	ON, OFF	OFF	43
#80	SET DEFAULT	YES, NO	NO	60
#89	HANDSET SWITCH	USE HANDSET, NO HANDSET	USE HANDSET	60

Printing reports and lists

You can print out the following reports and lists from your unit.

Basic feature list—provides you with the current settings of the basic features (see page 61).

Advanced feature list—provides you with the current settings of the advanced features (see page 61).

Telephone number list—provides you with phone numbers and their station names which are stored in automatic dialing. Codes in the phone number shows;

P: A pause has been entered.

[]: A secret phone number has been entered.

F: A flash has been entered.

(The telephone number is not printed.)

Journal report—keeps records of fax transmissions and receptions. This report will be printed automatically after every 35 fax communications, but can be printed manually. You can change the setting of the journal auto print feature (see page 63).

Transmission report—provides you with a printed record of the fax transmission result (see pages 63 and 64).

How to print reports and lists

1 Press **MENU** until the following is displayed.

PRINT LIST

2 For the **basic feature list**, press **#**, then **1**.

BASIC LIST

For the **advanced list**, press **#**, then **2**.

ADVANCED LIST

For the **telephone number list**, press **#**, then **3**.

TEL NO. LIST

For the **journal report**, press **#**, then **4**.

JOURNAL REPORT

3 Press **START/COPY/SET** to start printing.

•To interrupt printing, press **STOP**.

4 After printing, press **MENU**.

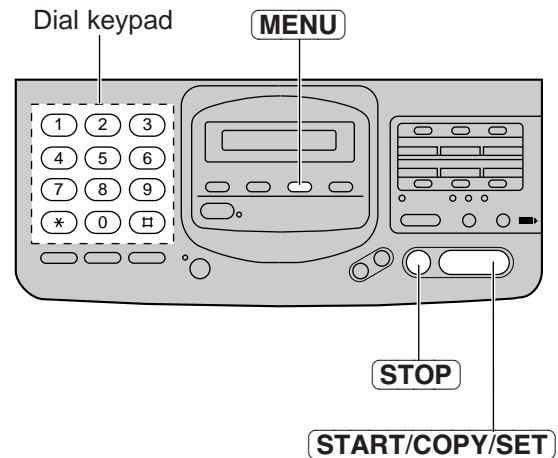

Setting the transmission report printing

One of the following choices is available.

ERROR: The transmission report will print out only when fax transmission fails (pre-selected setting).

ON: The report will always print out, indicating whether fax transmission is successful or not.

OFF: The report will not print.

1 Press **MENU**.

SYSTEM SET UP

2 Press **#**, then **0** **4**.

TX-REPORT MODE

3 Press **START/COPY/SET**.

MODE=ERROR [▲▼]

4 Press ▲ or ▼ to select the desired setting.

5 Press **START/COPY/SET**.

6 Press **MENU**.

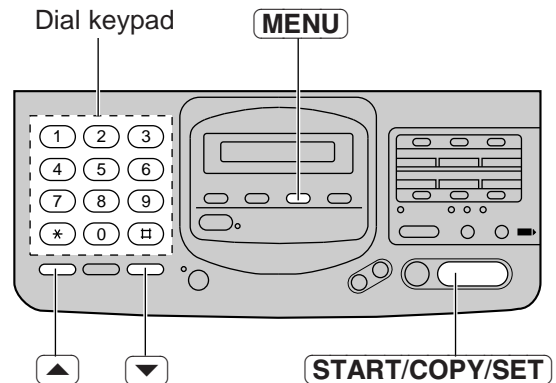

Setting journal auto print

This unit will automatically print a journal report after every 35 fax communications. After printing, the journal memory will be erased and only subsequent activity will be recorded.

When this feature is deactivated, the unit will store the records of the last 35 fax communications, but the unit will not print the journal report automatically.

1 Press **MENU**.

SYSTEM SET UP

2 Press **#**, then **2** **2**.

AUTO JOURNAL

3 Press **START/COPY/SET**.

MODE=ON [▲▼]

4 Press ▲ or ▼ to select the desired setting.

5 Press **START/COPY/SET**.

6 Press **MENU**.

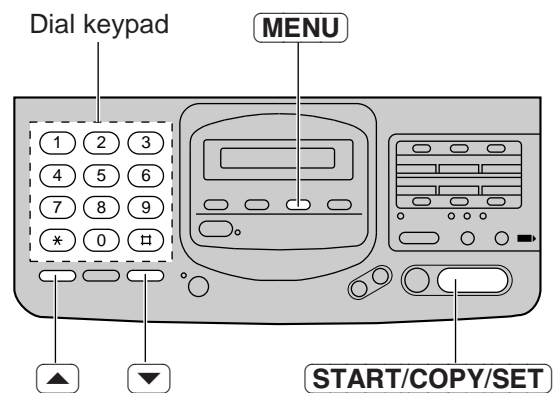

Sample of journal report

y JOURNAL z		JAN. 25 1996 05:22PM					
NO.	OTHER FACSIMILE	START TIME	USAGE TIME	MODE	PAGES	RESULT	*CODE
01	1234567	JAN. 21 02:14PM	00'25	TX	01	OK	
02	9998765	JAN. 21 02:17PM	00'38	TX	02	OK	
03	2121444	JAN. 21 02:18PM	00'28	RX	01	OK	
04	555556677	JAN. 22 10:35AM	00'58	TX	03	COMMUNICATION ERROR	(43)
05			01'50	TX	05	OK	
				RX	03	OK	

Sample of transmission report

y XMT REPORT z		JAN. 20 1996 01:19PM					
NO.	OTHER FACSIMILE	START TIME	USAGE TIME	MODE	PAGES	RESULT	*CODE
01	COMPANY ABC	JAN. 20 01:18PM	00'51	TX	00	COMMUNICATION ERROR	(43)

Communication result (see below.)

Error code (for service personnel use only)

Communication result on the report

When a problem has occurred, one of the following messages will be printed on the transmission and journal reports.

PRINTED MESSAGE	CODE	MEANING
COMMUNICATION ERROR	41-47 FF	A transmission or reception error occurred. Try again or check with the other party.
DOCUMENT JAMMED	—	The document is jammed. Remove the jammed document (see page 69).
JUNKMAIL PROH. REJECT	—	The junk mail prohibitor of your unit rejected fax reception (see page 41).
NO DOCUMENT	—	The document was not fed into the unit properly. Try again.
NO RESPONSE	40 52	The receiving unit was busy or ran out of recording paper. Try again.
PAPER JAMMED	—	The recording paper is jammed. Clear the jammed paper (see page 68).
PAPER OUT	—	The unit ran out of recording paper. Install a recording paper (see page 9).
PRESSED THE STOP KEY	—	The STOP button was pressed, and fax communication was canceled.
PRINTER OVERHEATED	—	Printer was overheated. Let the unit cool down.
THE COVER WAS OPENED	—	The back lid was open. Close it and try again.
OK	—	Fax communication was successful.

Error messages on the display

If the unit detects a problem, the following messages will appear on the display.

DISPLAY MESSAGE	CAUSE AND REMEDY
CALL SERVICE	<ul style="list-style-type: none"> There is something wrong with the unit. Contact our service personnel (see page 74).
CHECK COVER	<ul style="list-style-type: none"> The back lid is open. Close it.
CHECK CRADLE	<ul style="list-style-type: none"> The handset and handset cradle have been removed when you connect the power cord. <ul style="list-style-type: none"> When you want to use the handset and handset cradle, install the handset cradle correctly (see page 8). When you do not use the handset and handset cradle, set the handset switch to NO HANDSET (see page 60). Then, disconnect and connect the power cord again.
CHECK DOCUMENT	<ul style="list-style-type: none"> The document is not fed into the unit properly. Reinsert the document. If the misfeeding occurs frequently, clean the document feeder rollers inside the unit (see page 71). If the problem remains, adjust the feeder pressure (see page 70).
CHECK MEMORY	<ul style="list-style-type: none"> Memory (phone numbers, parameters, etc.) has been erased. Re-program.
MECHA ERROR	<ul style="list-style-type: none"> A mechanical error occurred. Open the back lid and re-install the recording paper (see page 9).
MEMORY FULL	<ul style="list-style-type: none"> There is no room left in memory to record a message. Erase some or all of the messages (see pages 29 and 46).
NO RESPONSE	<ul style="list-style-type: none"> The receiving unit is busy or ran out of recording paper. Try again.
NO TEL GREETING	<ul style="list-style-type: none"> The TEL/FAX greeting message has not been recorded. Record a greeting message (see page 54).
OUT OF PAPER	<ul style="list-style-type: none"> The unit ran out of recording paper. Install a new recording paper (see page 9).
PAPER JAMMED	<ul style="list-style-type: none"> A recording paper jam occurred. Clear the jammed paper (see page 68).
POLLING ERROR	<ul style="list-style-type: none"> The other fax machine does not provide the polling function. Check with the other party.
REDIAL TIME OUT	<ul style="list-style-type: none"> The receiving unit is busy or ran out of recording paper. Try again.
REMOVE DOCUMENT	<ul style="list-style-type: none"> The document is jammed. Remove the jammed document (see page 69). Attempted to transmit a document longer than 600 mm (23⁵/₈"). Press the STOP button and remove the document (see page 69). Divide the document into two or more sheets and try again.
TRANSMIT ERROR	<ul style="list-style-type: none"> A transmission error occurred. Try again.
UNIT OVERHEATED	<ul style="list-style-type: none"> The unit is too hot. Let the unit cool down.

Before requesting help

General

PROBLEM	CAUSE & REMEDY
I cannot make and receive calls.	<ul style="list-style-type: none">•The power cord or telephone line cord is not connected. Check the connections (see page 10).
I cannot make calls.	<ul style="list-style-type: none">•The dialing mode setting is wrong. Check the selector (see page 10).
The unit does not work.	<ul style="list-style-type: none">•Disconnect the unit from the telephone line and connect to a known working phone. If the working phone operates properly, call your service center to have the unit repaired. If the working phone does not operate properly, contact your telephone company.
The unit does not ring.	<ul style="list-style-type: none">•The ringer volume is set to OFF. Adjust it to a suitable level (see page 16).
The REDIAL/PAUSE button does not function properly.	<ul style="list-style-type: none">•If this button is pressed during dialing, a pause will be inserted. If this button is pressed immediately after obtaining a dial tone, the last number dialed will be redialed.
During programming, I cannot enter the activation code or the prohibitor ID.	<ul style="list-style-type: none">•Whole or part of the number is the same as another code or ID. Change the number (see pages 41, 44 and 50).

Fax Transmission

PROBLEM	CAUSE & REMEDY
The other party complains that letters on their received document are distorted.	<ul style="list-style-type: none">•If your line has special telephone services such as call waiting, the service may have been activated during fax transmission. Connect the unit to a line that does not have such services.•An extension telephone on the same line is off the hook. Hang up and try again.
The other party complains that dirty patterns or black lines appear on their received documents.	<ul style="list-style-type: none">•The glass or rollers are dirty. Clean them (see page 71).
I cannot make an international fax call.	<ul style="list-style-type: none">•Use the overseas transmission mode (see page 39).•Add two pauses at the end of the phone number (see page 36).

Fax Reception

PROBLEM	CAUSE & REMEDY
I cannot receive documents automatically.	<ul style="list-style-type: none"> ● The receive mode is set to the TEL mode. Set to the ANS/FAX, TEL/FAX or FAX mode. ● The time to answer the call may be too long. Decrease the number of rings (see pages 23, 24 and 26). ● The greeting message is too long. Shorten the message (see page 54). ● The junk mail prohibitor is set to on (see page 41).
The recording image is faint.	<ul style="list-style-type: none"> ● The sender transmitted a faint document. Request them to transmit a clearer copy of the document.
The received document is blank.	<ul style="list-style-type: none"> ● The recording paper roll is installed incorrectly. Make sure that the shiny side of the paper is facing down and re-install the paper (see page 9).

Answering Device

PROBLEM	CAUSE & REMEDY
No voice messages have been recorded in the ANS/FAX mode.	<ul style="list-style-type: none"> ● The memory is full. Erase some or all of the messages (see pages 29, 46 and 52).
I cannot retrieve recorded messages from a remote phone.	<ul style="list-style-type: none"> ● Make sure that you use the remote operation ID correctly (see page 50).
Messages in the mailbox do not play back.	<ul style="list-style-type: none"> ● The mailbox password is wrong. Enter the correct password (see page 44).

Copying

PROBLEM	CAUSE & REMEDY
A dirty pattern or a black line appears on the copied documents.	<ul style="list-style-type: none"> ● The glass or rollers are dirty. Clean them (see page 71).
The copied document is blank.	<ul style="list-style-type: none"> ● The recording paper roll is installed incorrectly. Make sure that the shiny side of the paper is facing down and re-install the paper (see page 9).

If a power failure occurs

- This unit does not function during a power failure.
- The memory contents will not be erased.
- If the programmed start time has passed during a power failure, delayed transmission will be attempted after power is restored.

Clearing a recording paper jam

If the unit does not eject any recording paper during reception or copying, the recording paper has jammed. Remove the jammed paper as shown below.

- 1
 - A Open the back lid by lifting up the tabs located on both sides.
 - B Press the green lever to release the paper cutter.

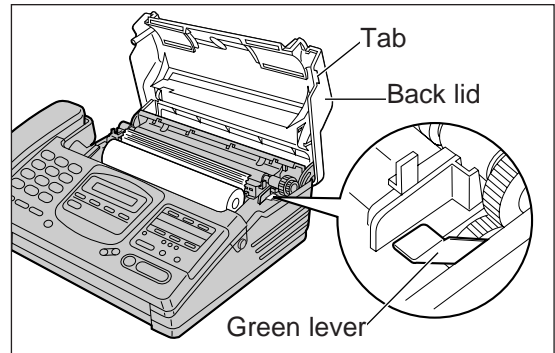

- 2 Pull up the transparent guide and remove the piece of paper.
 - If the transparent guide is not pulled up, press the green lever again.

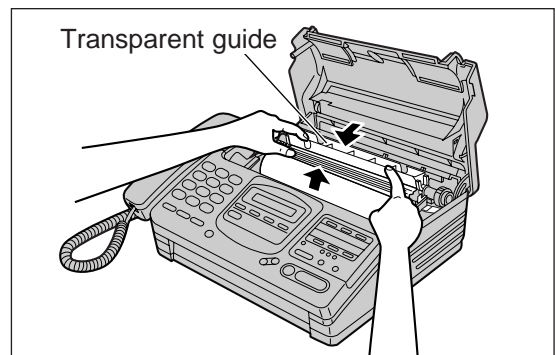

- 3 Replace the transparent guide and recording paper roll in the proper direction, and insert the leading edge of the paper between the recording paper roller and the silver plate.
 - Make sure that there is no slack in the paper roll.

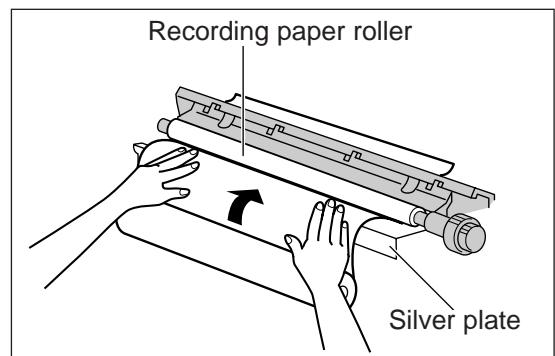

- 4 Close the back lid by gently pressing down on both ends.

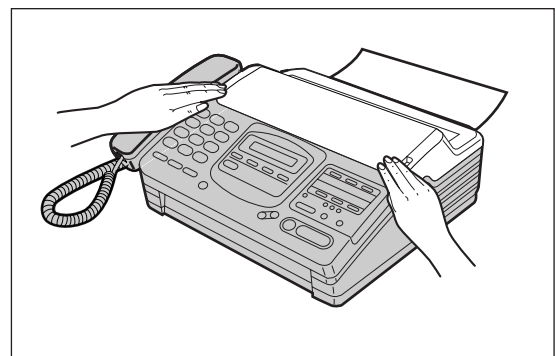

Clearing a document jam

If the unit does not release an original document during feeding, remove it as shown below.

- 1** Open the front lid by pressing the front lid open button.
- 2** Remove the jammed document.
- 3** Close the front lid by gently pressing down on both ends.

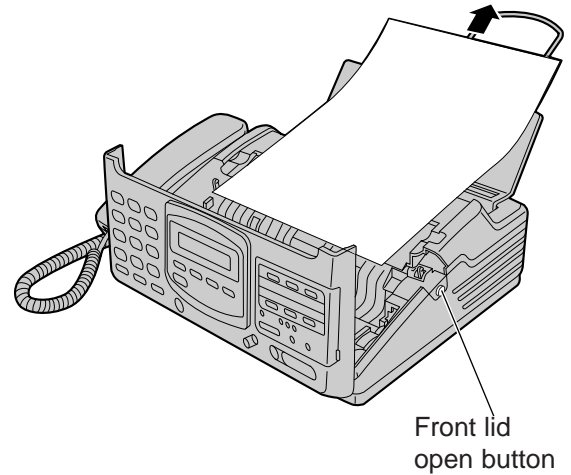

Adjusting the feeder pressure

No feeding or multiple feeding occurs frequently, adjust the feeder pressure.

- 1 Open the front lid by pressing the front lid open button.
- 2 Shift the position of the lever by using an instrument with a pointed end, like a clip or ball-point pen.

Position A: Select this when documents do not feed.
Position B: Standard position (pre-selected)
Position C: Select this when documents multiple feed.
- 3 Close the front lid by gently pressing down on both ends.

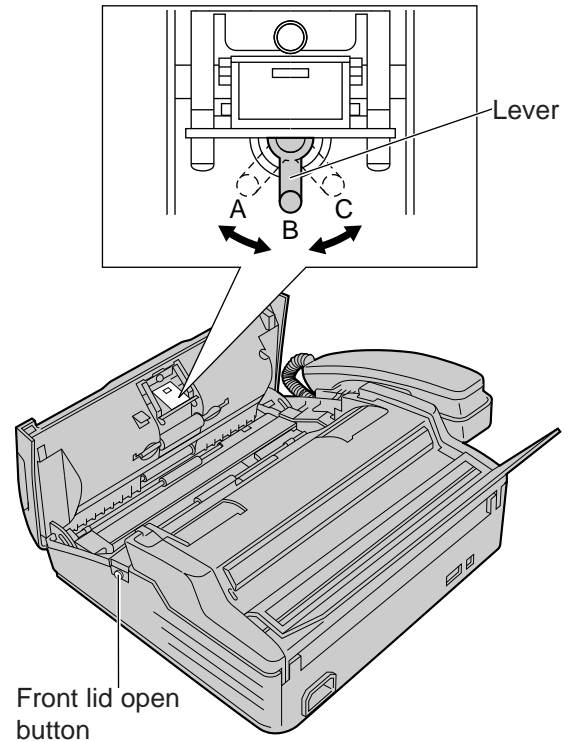

Removing the handset cradle

To save space or to use the unit mainly for faxes, you may remove the handset cradle.

- 1 Set the handset switch to NO HANDSET (see page 60).
- 2 Pull the hooks to the right in the order as shown, while lifting up the handset cradle.
- 3 Disconnect and connect the power cord again.

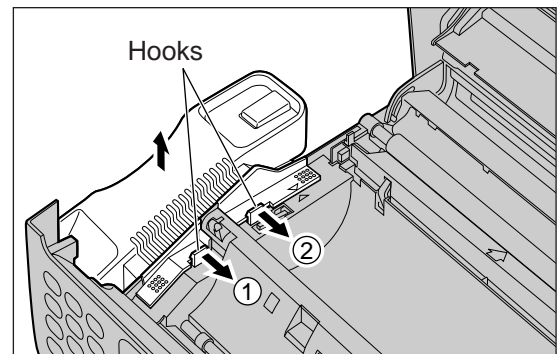

Caution:

- If the handset and handset cradle have been removed when you connect the power cord, an alarm will sound and the following message will be displayed.

CHECK CRADLE

Set the handset switch to NO HANDSET (see page 60).

Cleaning the inside of the unit

If misfeeding occurs frequently or dirty patterns or black bands appear on a copied or transmitted document, clean the document feeder rollers, sub roller, rubber flap, white plate and glass.

- 1** Disconnect the power cord and the telephone line cord.
- 2** Open the front lid by pressing the front lid open button.
- 3** Clean the document feeder rollers and sub roller with a cloth moistened with isopropyl rubbing alcohol, and let dry thoroughly.
- 4** Clean the rubber flap with a cotton swab moistened with isopropyl rubbing alcohol, and let dry thoroughly.
- 5** Clean the white plate and glass with a soft dry cloth.
- 6** Close the front lid by gently pressing down on both ends.
- 7** Connect the power cord and the telephone line cord.

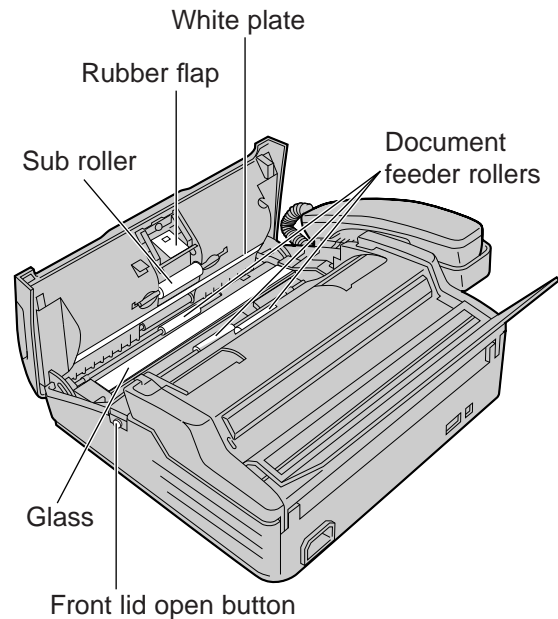

Caution:

- Do not use paper products (such as paper towels or tissues) to clean the inside of the unit.

FCC information

If required by the telephone company, inform them of the following.

- FCC Registration No.:
(found on the bottom of the unit)
- Ringer Equivalence No.:
(found on the bottom of the unit)
- The particular telephone line to which the equipment is connected.

This unit must not be connected to a coin operated line. If you are on a party line, check with your local telephone company.

Ringer Equivalence Number (REN):

This REN is useful in determining the quantity of devices you may connect to your telephone line and still have all of those devices ring when your telephone number is called. In most but not all areas, the sum of the REN's of all devices connected to one line should not exceed five (5.0). To be certain of the number of devices you may connect to your line, as determined by the REN, you should contact your local telephone company to determine the maximum REN for your calling area.

In the event that terminal equipment causes harm to the telephone network, the telephone company should notify the customer, if possible, that service may be stopped. However, where prior notice is impractical, the company may temporarily cease service providing that they:

- a) Promptly notify the customer.
- b) Give the customer an opportunity to correct the problem with their equipment.
- c) Inform the customer of the right to bring a complaint to the Federal Communication Commission pursuant to procedures set out in FCC Rules and Regulations Subpart E of Part 68.

The Telephone Company may make changes in its communications facilities, equipment operations, or procedures where such action is reasonably required in the operation of its business and is not inconsistent with the rules and regulations in FCC Part 68. If such changes can be reasonably expected to render any customer terminal equipment incompatible with telephone company communications facilities, or require modification or

alteration of such terminal equipment, or otherwise materially affect its use or performance, the customer shall be given adequate notice in writing, to allow the customer an opportunity to maintain uninterrupted service.

CAUTION:

Any changes or modifications not expressly approved by the party responsible for compliance could void the user's authority to operate this device.

When programming emergency numbers and/or making test calls to emergency numbers:

1. Remain on the line and briefly explain to the dispatcher the reason for the call before hanging up.
2. Perform such activities in the off-peak hours; such as early morning or late evenings.

This telephone provides magnetic coupling to hearing aids.

NOTE:

This equipment has been tested and found to comply with the limits for a Class B digital device, pursuant to Part 15 of the FCC Rules. These limits are designed to provide reasonable protection against harmful interference in a residential installation. This equipment generates, uses, and can radiate radio frequency energy and, if not installed and used in accordance with the instructions, may cause harmful interference to radio communications. However, there is no guarantee that interference will not occur in a particular installation. If this equipment does cause harmful interference to radio or television reception, which can be determined by turning the equipment off and on, the user is encouraged to try to correct the interference by one or more of the following measures:

- Reorient or relocate the receiving antenna.
- Increase the separation between the equipment and receiver.
- Connect the equipment into an outlet on a circuit different from that to which the receiver is connected.
- Consult the dealer or an experienced radio/TV technician for help.

Matsushita Consumer Electronics Company,
Division of Matsushita Electric Corporation of America
One Panasonic Way, Secaucus,
New Jersey 07094

Panasonic Sales Company (“PSC”)
Division of Matsushita Electric of
Puerto Rico, Inc.
Ave. 65 de Infantería, Km. 9.5, San Gabriel
Industrial Park, Carolina, Puerto Rico 00985

PANASONIC

Facsimile Products

Limited Warranty

Matsushita Consumer Electronics Company or Panasonic Sales Company (collectively referred to as “the warrantor”), will repair this product with new or refurbished parts, free of charge, in the USA or Puerto Rico for one (1) year from the date of original purchase in the event of a defect in materials or workmanship.

Batteries (when applicable)—New rechargeable batteries in exchange for defective rechargeable batteries for ten (10) days from the date of original purchase. Non-rechargeable batteries are not warranted.

Carry-in or mail-in service in the USA or Puerto Rico can be obtained during the warranty period by contacting a Matsushita Services Company (MSC) Factory Servicenter listed in the Servicenter Directory. Or call, toll free, 1-800-HELP FAX (1-800-435-7329) to locate a MSC Factory Servicenter. Carry-in or mail-in service in Puerto Rico can be obtained during the warranty period by calling the local telephone number in the Servicenter Directory.

This warranty is extended only to the original purchaser. A purchase receipt or other proof of date of original purchase will be required before warranty service is rendered.

This warranty only covers failures due to defects in material and workmanship which occur during normal use and (when applicable) does not cover the print and ink cartridge, the toner cartridge and drum unit or the film cartridge. The warranty does not cover damages which occurred in shipment, or failures which are caused by products not supplied by the warrantor, or failures which result from accident, misuse, abuse, neglect, mishandling, faulty installation, misapplication, set-up adjustments, improper operation or maintenance, alteration, modification, line power surge, improper voltage supply, lightning damage, signal reception problems, commercial use such as hotel, office, restaurant, or other business or rental use of the product, or serviced by anyone other than a MSC Factory Servicenter or a MSC authorized Servicenter, or damage that is attributable to acts of God.

LIMITS AND EXCLUSIONS

There are no express warranties except as listed above.

THE WARRANTOR SHALL NOT BE LIABLE FOR INCIDENTAL OR CONSEQUENTIAL DAMAGES RESULTING FROM THE USE OF THIS PRODUCT, OR ARISING OUT OF ANY BREACH OF THIS WARRANTY. ALL EXPRESS AND IMPLIED WARRANTIES, INCLUDING THE WARRANTIES OF MERCHANTABILITY, ARE LIMITED TO THE APPLICABLE WARRANTY PERIOD SET FORTH ABOVE.

Some states do not allow the exclusion or limitation of incidental or consequential damages, or limitations on how long an implied warranty lasts, so the above exclusions or limitations may not apply to you.

This warranty gives you specific legal rights and you may also have other rights which vary from state to state. If a problem with this product develops during or after the warranty period, you may contact your dealer or Servicenter. If the problem is not handled to your satisfaction, then write to the Customer Satisfaction Center at the company address indicated above.

Service center directory

OPERATION ASSISTANCE • FAX ADVANTAGE PROGRAM

DIAL TOLL FREE: 1-800-HELP-FAX (1-800-435-7329) (9:00am–8:00pm Monday–Friday, EST)

PRODUCT INFORMATION • LITERATURE REQUESTS • DEALER LOCATIONS

Customer Satisfaction Center 2F-3, One Panasonic Way, Secaucus, NJ 07094 (Headquarters)
201-348-9090 (9:00am–8:00pm Monday–Friday, EST)

ACCESSORY PURCHASES

1-800-332-5368 (Consumer orders only)

Matsushita Services Company Accessory Order Office, 20421-84th Avenue South Kent, WA 98032
(6:00am–6:00pm Monday–Friday, 6:00am–10:30am Saturday, PST)
(Visa, Mastercard, Discover card, American Express, Check)

AUTHORIZED SERVICENTERS

CALIFORNIA

6550 Katella Avenue
Cypress, CA 90630
Phone (714) 373-7425
Fax (714) 894-8534

800 Dubuque Avenue
S. San Francisco,
CA 94080
Phone (415) 871-6373
Fax (415) 871-6840

20201 Sherman Way
Suite 102
Canoga Park, CA 91306
Phone (818) 709-1775
Fax (818) 709-2165

3878 Ruffin Road
Suite A
San Diego, CA 92123
Phone (619) 560-9200
Fax (619) 560-1831

COLORADO

1640 South Abilene Suite D
Aurora, CO 80012
Phone (303) 752-2024
Fax (303) 752-0610

FLORIDA

3700 North 29th Avenue
Suite 102
Hollywood, FL 33020
Phone (954) 925-2880
Fax (954) 925-5224

4710 Eisenhower
Boulevard Suite A1
Tampa, FL 33634
Phone (813) 884-4746
Fax (813) 886-4564

GEORGIA

8655 Rosewell Road
Suite 100
Atlanta, GA 30350
Phone (770) 518-6301
Fax (770) 518-6306

HAWAII

99-859 Iwaiwa Street
Aiea, Hawaii 96701
Phone (808) 488-1996
Fax (808) 486-4369

ILLINOIS

*1703 North Randall Road
Elgin, IL 60123
"12:30 to 4:30, Mon-Fri"
Phone (847) 468-5464
Fax (847) 468-5465

9060 Golf Road
Niles, IL 60714
Phone (847) 608-1010
Fax (847) 299-1710

MARYLAND

Sulphur Springs
Business Park
1638 Sulphur Springs Road
Baltimore, MD 21227
Phone (410) 242-2607
Fax (410) 247-3047

MASSACHUSETTS

60 Glacier Drive, Suite G
Westwood, MA 02090
Phone (617) 329-4280
Fax (617) 329-0586

*pick-up/drop-off only

MICHIGAN

37048 Van Dyke Avenue
Sterling Heights, MI 48312
Phone (810) 939-2060
Fax (810) 939-2638

MINNESOTA

7850-12th Avenue South
Airport Business Center
Bloomington, MN 55425
Phone (612) 854-8624
Fax (612) 854-2089

OHIO

2236 Waycross Road
Cincinnati, OH 45240
Phone (513) 851-4180
Fax (513) 851-8443

PENNSYLVANIA

2221 Cabot Boulevard West
Suite B
Langhorne, PA 19047
Phone (215) 741-0661
Fax (215) 741-0521

Chartiers Valley
Shopping Center
1025 Washington Pike
Bridgeville, PA 15017
Phone (412) 257-4522
Fax (412) 257-4650

TENNESSEE

919-8th Avenue South
Nashville, TN 37203
Phone (615) 244-4434
Fax (615) 244-6713

TEXAS

7482 Harwin Drive
Houston, TX 77036
Phone (713) 781-1528
Fax (713) 781-0643

13615 Welch Road Suite 101
Farmers Branch, TX 75244
Phone (214) 385-1975
Fax (214) 960-7626

WASHINGTON

20425-84th Avenue South
Kent, WA 98032
Phone (206) 872-7922
Fax (206) 872-0918

Service in Puerto Rico

**Matsushita Electric
of Puerto Rico, Inc.
Panasonic Sales Company/
Factory Servicenter**

Ave. 65 de Infantería, Km. 9.5
San Gabriel Industrial Park
Carolina, Puerto Rico 00985
Phone (809) 750-4300
Fax (809) 768-2910

REPAIR INQUIRIES

Regional Customer Care Department

EAST (PCE)

2221 Cabot Boulevard West
Suite A
Langhorne, PA 19047
Phone (215) 741-0676
Fax (215) 750-6492

Covers:

CT, DE, ME, MD, MA, NH, NJ,
NY, PA, RI, VT, VA, DC, WV

EAST (PCE)

1225 Northbrook Parkway
Suite 2-390
Suwannee, GA 30174
Phone (404) 338-6860
Fax (404) 338-6548

Covers:

AL, FL, GA, MS, NC, SC, TN

CENTRAL (PCC)

1707 North Randall Road
Elgin, IL 60123
Phone (847) 468-5530
Fax (847) 468-5528

Covers:

AR, IL, IN, IA, KS, KY, LA, MI,
MN, MO, NE, ND, OK, SD, TX,
WI, OH

WEST (PCW)

6550 Katella Avenue
Cypress, CA 90630
Phone (714) 373-7440
Fax (714) 373-7447

Covers:

AK, AZ, CA, CO, ID, MT, NV,
NM, OR, UT, WA, WY, HI

PARTS DISTRIBUTION LOCATIONS

To locate parts distributors in your area (within the USA)
DIAL TOLL FREE 1-800-545-2672 (24 hours a day, 7 days a week)

(960607)

Information for users

For product service

- Service centers are listed on page 74.
- Call toll free 1-800-545-2672 for the location of an authorized service center.

When you ship the product

- Carefully pack your unit, preferably in the original carton.
- Attach a letter, detailing the symptom or problem, to the outside of the carton.
- Send the unit to an authorized service center, prepaid and adequately insured.
- Do not send your unit to the Matsushita Consumer Electronics Company or to any executive or regional sales offices. These locations do not repair consumer products.

Accessory order information

Use the following types of recording paper for replacement. For accessory order, call toll free 1-800-332-5368.

Model No.	Description	Comment
KX-A106	Standard Thermal Recording Paper	216 mm×30 m (8½"×98') roll, with 25 mm (1") core
KX-A116	Standard Thermal Recording Paper	216 mm×50 m (8½"×164') roll, with 25 mm (1") core
KX-A125	Super Thermal Recording Paper (Like plain paper)	216 mm×30 m (8½"×98') roll, with 25 mm (1") core

Specifications

1. Applicable Lines:	Public Switched Telephone Network
2. Document Size:	Max. 216 mm (8½") in width Max. 600 mm (23⅝") in length
3. Effective Scanning Width:	208 mm (8⅜")
4. Printing Paper Size:	216 mm × max. 50 m (8½" × 164') roll
5. Effective Printing Width:	208 mm (8⅜")
6. Transmission Time*:	Approx. 15 s/page (Original mode) Approx. 30 s/page (G3 Normal mode)
7. Scanning Density:	Horizontal: 8 pels/mm (203 pels/inch) Vertical: 3.85 lines/mm (98 lines/inch)—Standard mode 7.7 lines/mm (196 lines/inch)—Fine/Halftone mode 15.4 lines/mm (392 lines/inch)—Superfine mode
8. Halftone Level:	64-level
9. Scanner Type:	CCD image sensor
10. Printer Type:	Thermal printing
11. Data Compression System:	Modified Huffman (MH), Modified READ (MR)
12. Modem Speed:	9600/7200/4800/2400 bps; Automatic Fallback
13. Operating Environment:	5–35 °C (41–95 °F), 45–85 % RH (Relative Humidity)
14. Dimensions (H×W×D):	118×351×265 mm (4 ²¹ / ₃₂ "×13 ¹³ / ₁₆ "×10 ⁷ / ₁₆ "
15. Mass (Weight):	Approx. 3.7 kg (8.2 lb.)
16. Power Consumption:	Standby: Approx. 3.5 W Transmission: Approx. 16 W Reception: Approx. 28 W Copy: Approx. 40 W Maximum: Approx. 120 W
17. Power Supply:	120 V AC, 60 Hz (This unit will not function at 50 Hz.)
18. Total Recording Time:	Approx. 18 minutes (including the greeting message). Recording time may be reduced by caller side background noise.

*Transmission speed depends upon the contents of the pages, resolution, telephone line conditions and capability of receiving unit. 15 second speed based upon CCITT No.1 Test Chart.

CCITT No. 1 Test Chart

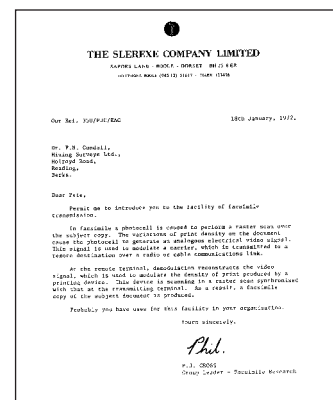

Note:

- Any details given in these instructions are subject to change without notice.
- The pictures and illustrations in these instructions may vary slightly from the actual product.

Speed dialer list

Station No.	Name/Phone No.	Station No.	Name/Phone No.
00		25	
01		26	
02		27	
03		28	
04		29	
05		30	
06		31	
07		32	
08		33	
09		34	
10		35	
11		36	
12		37	
13		38	
14		39	
15		40	
16		41	
17		42	
18		43	
19		44	
20		45	
21		46	
22		47	
23		48	
24		49	

Speed dialer list

Station No.	Name/Phone No.	Station No.	Name/Phone No.
00		25	
01		26	
02		27	
03		28	
04		29	
05		30	
06		31	
07		32	
08		33	
09		34	
10		35	
11		36	
12		37	
13		38	
14		39	
15		40	
16		41	
17		42	
18		43	
19		44	
20		45	
21		46	
22		47	
23		48	
24		49	

Index

A	ANS/FAX mode	14, 22	M	MAIL BOX button	45
	ANS/FAX ring count	23		Mailbox alert	46
	Answering device volume	16		Mailbox password	44
	Automatic dialing	32		MANUAL RECEIVE mode	14
	AUTO RECEIVE button	14		MEMO/2WAY REC button	30, 31
	AUTO RECEIVE mode	14		Message alert	56
				Message transfer	47
C	Call counter	29		MUTE button	17
	Caller's recording time	56	N	NEW MSGS. PLAY BACK button	29
	CHECK button	55	O	Overseas transmission mode	39
	Cleaning	71	P	Pager call	47
	COPY button	28		PAUSE button	36
D	Date and time	11		Polling	37
	Delayed transmission	38	Q	QUICK button	30
	DELETE key	13	R	REC button	54
	Dialing mode	10		Recording time alert	57
	DIGITAL SP-PHONE button	17		Recording time for ANS/FAX greeting message	57
	DIRECTORY button	33, 34		REDIAL button	36
	Display contrast	58		Remote operation ID	50
E	Electronic telephone directory	34		Remote fax activation code	40
	ERASE button	29, 55		REPEAT button	30
	Error message	65		RESOLUTION button	18
F	Facsimile telephone number	12		Ring pattern detection	42
	Fax auto redial	19		Ringer volume	16
	FAX mode	14, 24	S	SECRET key	32
	Fax pager	43		SELECT button	54
	FAX ring count	24		Set default	60
	Fax voice guidance	19, 21, 59		Silent fax recognition ring	27
	Fax voice guidance volume	16		SKIP button	30
	Feeder pressure	70		SLOW button	30
	FLASH button	36		SPACE key	13
	Friendly reception	21, 59		Speaker volume	16
G	Greeting messages	54	T	TEL mode	14
H	Handset switch	60		TEL/FAX mode	14, 25
	Handset volume	16		TEL/FAX ring count	26
	HELP button	10		Telephone number list	62
I	INSERT key	13		Toll saver	23
J	Journal auto print	63		TONE button	36
	Journal report	62, 64		Transmission report	62, 63
	Junk mail prohibitor	41	V	Voice contact	35
L	Logo	12		Voice guide	20
	Logo print position	58		Voice time/day stamp	29
	LOWER key	32, 33		VOLUME button	16

Panasonic FAX ADVANTAGE PROGRAM

We are proud to present the Panasonic Fax Advantage Program. It's an incredible service program that's full of exciting advantages!

Customer Satisfaction

In support of our one-year limited warranty* (parts and labor) on our current fax product line, Panasonic is proud to offer you the following service options during the limited warranty period:

- 1 If you mail-in or carry-in your fax unit to one of our Regional Servicenters, the product will be repaired and returned to you, or...
- 2 If you call our 1-800-HELPFAX (1-800-435-7329) toll-free number, you will receive a refurbished replacement product overnight or on the second business day (delivery depending on the time of your call.)

Support After The Sale

If you have a problem with your fax, just call our 1-800-HELPFAX (1-800-435-7329) toll-free number for friendly support and assistance. We have a highly-qualified team of experts who can diagnose, and most likely solve, your problem over the phone. Approximately 90% of our customers' problems are resolved with just a simple phone call.

The Fax Advantage Program covers the first year of purchase and works like this:

- 1 If you have a problem with your fax, call toll-free 1-800-HELPFAX (1-800-435-7329).
- 2 Talk to one of our experienced technical experts to diagnose (and most likely solve) your problem over the phone.
- 3 Providing that you may be entitled to Panasonic's service under the terms and conditions of the limited warranty**, we will arrange for a reconditioned replacement unit to be shipped to you overnight or second business day delivery, depending on the time of your call. The replacement unit will be completely refurbished, quality-tested by Panasonic technicians, and individually hand-inspected before it is shipped to you. You will keep the replacement unit and send your original unit to us, along with a copy of your receipt.
- 4 This receipt must be shipped back with your original unit to Panasonic Company (as per instructions enclosed in your

replacement unit's box).

Any unit that is replaced by Panasonic and not backed up by a proof of purchase by you will be subject to a minimum \$100.00 charge. Any unit that is replaced, but does not meet the terms and conditions of the limited warranty will be subject to additional charges, as per the program guidelines.

5 Once you receive your replacement unit, pack up your problem unit in the replacement unit's box. UPS will make 3 attempts within 10 days to pick-up your defective unit at no charge to you (should you be entitled to warranty service. If warranty conditions do not apply, you will be charged for all applicable shipping charges). The product must be properly packaged in the same manner as the replacement unit, utilizing the packing materials provided. You must make your unit available for UPS pick-up. If your unit is not available for UPS, you will be responsible for shipping unit back at your expense. Damage due to improper or inadequate packing will be charged back to your charge card as an out-of-warranty cost, as per the warranty stipulations.

Requirements:

6 You must give our technicians a valid credit card number. They will change your card account to cover any charges that are incurred by failure to send the problem product to Panasonic Company. If your problem unit is not eligible for warranty, you will be charged for the repair of the unit and for any shipping charges associated with this program. If you do not wish to pay out-of-warranty repair costs, you will be responsible for returning the replacement unit to Panasonic and for paying all shipping charges associated with this program including the overnight delivery of replacement product to you, shipment of problem unit to Panasonic, the replacement unit back to Panasonic and the return of your original unit back to you.

Acceptable credit cards:

Discover VISA
Master Card American Express (Optima)

Product that is not returned to Panasonic by 10 business days after shipment of the replacement product, will be charged to your account at Panasonic's Suggested Retail Price (see dealer for details).

Credit status will be verified prior to sending the replacement product.

Proof of Purchase must be included with the returned unit to verify warranty status.

Any parts and labor that are not covered by the limited warranty* will be charged as a non-warranty repair and billed at Panasonic's current rate for parts and labor.

*See the warranty stipulations in these instructions.

**Replacement program excludes Puerto Rico and is subject to termination at any time without advance notice.



Matsushita Consumer Electronics Company, Division of Matsushita Electric Corporation of America
One Panasonic Way, Secaucus,
New Jersey 07094

Panasonic Sales Company, Division of Matsushita Electric of Puerto Rico, Inc. ("PSC")
Ave. 65 de Infantería, Km. 9.5
San Gabriel Industrial Park, Carolina,
Puerto Rico 00985